



OWENS CORNING®
ENCLOSURE SOLUTIONS
NFPA 285 Accepted Complete Walls





ENCLOSURE SOLUTIONS

NFPA 285 Accepted Complete Walls

This brochure provides design guidance for NFPA 285 evaluated wall assemblies and all of the critical details necessary to specify compliant assemblies including:

- Structural Options:
Steel Stud, Concrete, CMU
- Owens Corning Insulation Options:
FOAMULAR® XPS, EcoTouch® Flame Spread 25 Fiberglas™, EcoTouch® PINK® FIBERGLAS™, Thermafiber® RainBarrier®, Thermafiber® Safing™, Thermafiber® UltraBatt™
- Air/Water Barriers Options:
Dozens of accepted products and manufacturers
- Owens Corning Accessory Options:
JointSealR® Foam Joint Tape, Thermafiber® RainBarrier® Clip
- Exterior Cladding Options:
Many including masonry and non-masonry
- CAD Details:
Critical head, jamb, sill and transition details for a variety of insulation and cladding types

NFPA 285 Fire Evaluated Wall Assemblies

With Owens Corning² Enclosure Solutions you now have the design flexibility to cover most any project, of any size, with any exterior cladding, in any climate zone. Owens Corning® Enclosure Solutions have successfully passed NFPA 285^{1,2} fire evaluation² in many variations giving architects complete flexibility in exterior wall design. The systems are approved with FOAMULAR® extruded polystyrene continuous insulation under a variety of masonry veneer exterior finishes, or, with non-combustible Thermafiber® mineral wool continuous insulation under a variety of non-masonry claddings including metal panels. All of the continuous insulation options can be used over either steel stud frame, concrete, or masonry walls with dozens of alternate air/water resistive barrier products and manufacturers. Owens Corning® Enclosure Solutions provide you with the construction industry's most complete portfolio of wall system design options. This brochure summarizes NFPA 285 approved assemblies. See the Specification Guide tables in this brochure and the library of Enclosure Solutions publications for more information.

¹NFPA 285, Standard Fire Test Method for Evaluation of Fire Propagation Characteristics of Exterior Non-Load Bearing Wall Assemblies Containing Combustible Components; National Fire Protection Association, 1 Batterymarch Park, Quincy, Massachusetts 02169

²Some systems specified herein have been tested in accordance with NFPA 285. Some systems have been evaluated and acceptance extended via third party engineering analysis in accordance with ICC-ES Acceptance Criteria for Foam Plastic Insulation (AC 12), Section 6.6.

The Purpose of NFPA 285

NFPA 285 is required in the International Building Code (IBC) in multiple situations. For example, it is required in many situations when combustible air barriers are used or when foam plastic insulation is used in the exterior walls of construction types I, II, III or IV. These construction types, by code definition, have exterior walls constructed of non-combustible materials. The NFPA 285 test is to determine that combustibles, when exposed to fire on the exterior face of the wall, do not spread flame over the surface or through the core of the otherwise non-combustible wall assembly.

The test standard NFPA 285 is referenced in many sections of the IBC including 1403.5 for water resistive barriers, and Section 2603.5.5 for foam plastic insulation. NFPA 285, or a variation of it, has been referenced in each edition of the IBC since its first edition in 2000, and since the 1980's in the three model codes that preceded it. The now defunct ICBO Uniform Building Code first included the concept in the 1988 edition, requiring testing in accordance with the UBC Standard 17-6, a predecessor of NFPA 285.

The other two national model building codes of that era also required full scale testing for exterior walls. The 1982 SBCCI Standard, and the 1984 BOCA National (Basic) Building Codes stated in their foam plastics chapters, “Results of diversified or full scale fire tests reflecting an end use condition shall be submitted to the building official demonstrating that the (wall) assembly in its final form does not show any tendency to propagate flame over the surface or through the core when exposed on the exterior face to a fire source.” The intent was that a predecessor of NFPA 285 be utilized, the “Full Scale Multi-Story Test,” as it was called at the time.

The NFPA 285 Methodology

The 30 minute test is conducted on a full scale two story wall assembly, built as it would be in the field, on the front side of a three sided test structure. (See Figures 1 and 2 that are excerpts from NFPA 285)

The test wall, has a window in the center of the lower floor. (See Figures 2 and 3) The test scenario is that a flashover fire, unrelated to the combustibles in the wall, has occurred in the lower story room emitting a fire plume through the window and out of the room of origin. Early in the 30 minute exposure the fire plume wraps around the window head, extending up the exterior surface of the wall. (See Figure 4)

To pass, the wall assembly must limit fire spread vertically and horizontally away from the window. The extent of fire spread is determined visually, measured in feet, and by temperature that is measured by thermocouples placed throughout the wall assembly. Figure 5 shows a successful Owens Corning® Enclosure Solutions Wall System test with the brick veneer stripped away just above the window lintel. Note the very limited fire spread and melting of the foam continuous insulation.

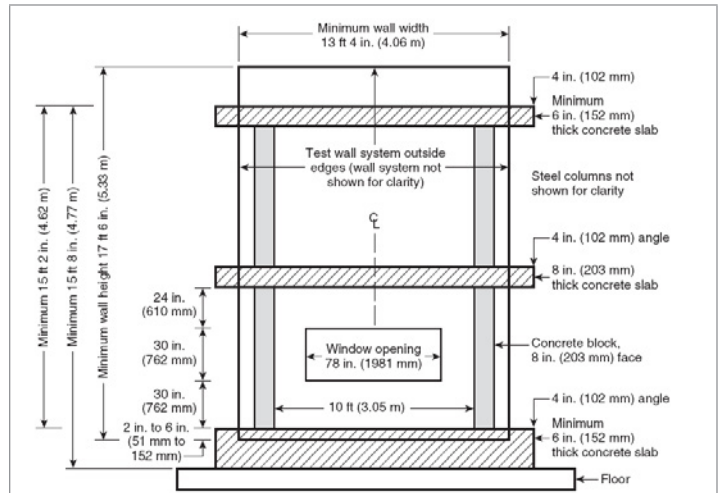

Figure 1: Elevation of test rig, test wall side

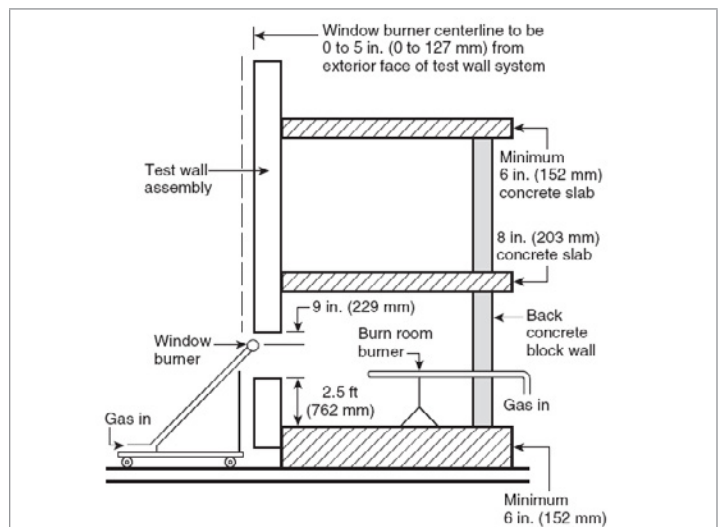

Figure 2: Section of test rig



Figure 3: Test wall under construction

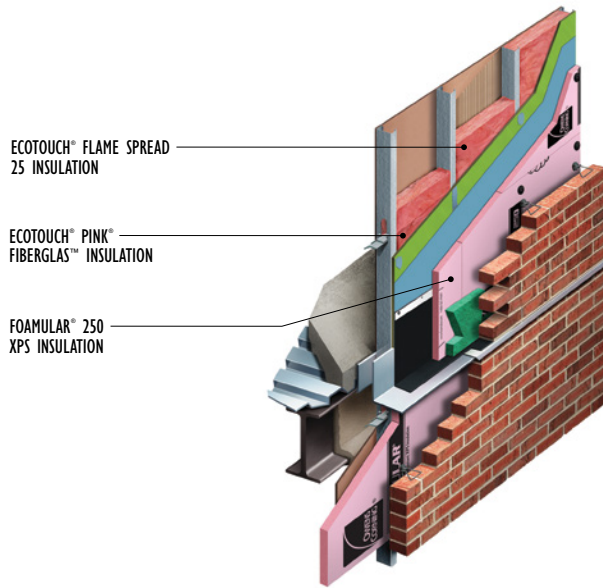

Figure 4: Fire emitting from the test window

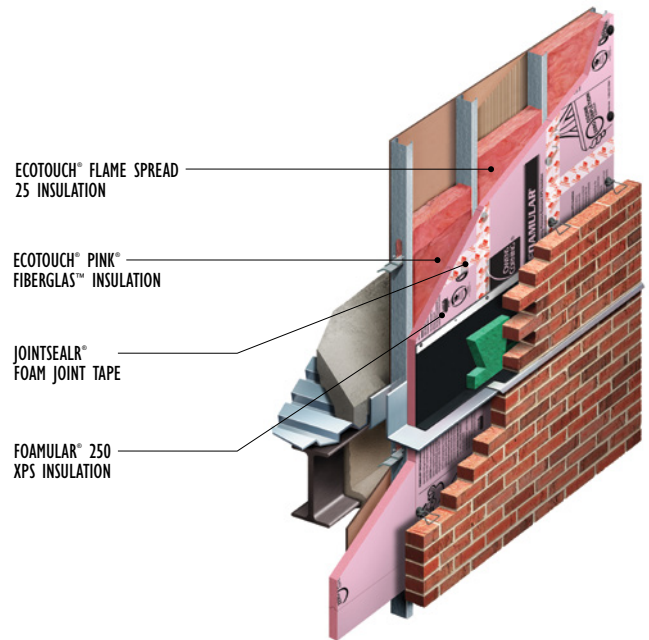

Figure 5: FOAMULAR® showing limited damage above the test window with brick veneer stripped away after the fire test

Steel Stud, FOAMULAR XPS®, Masonry Veneer



Fluid or Sheet WRB



Taped XPS Joints WRB

EIFS

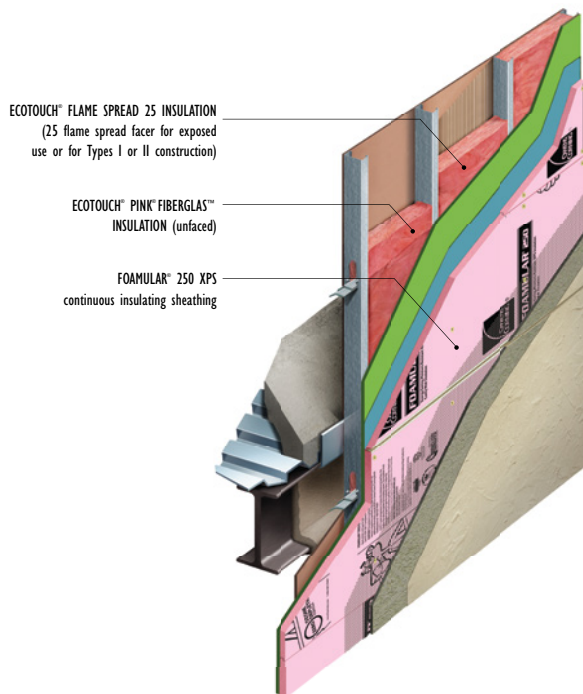

PM EIFS (system by others)

Concrete Panel

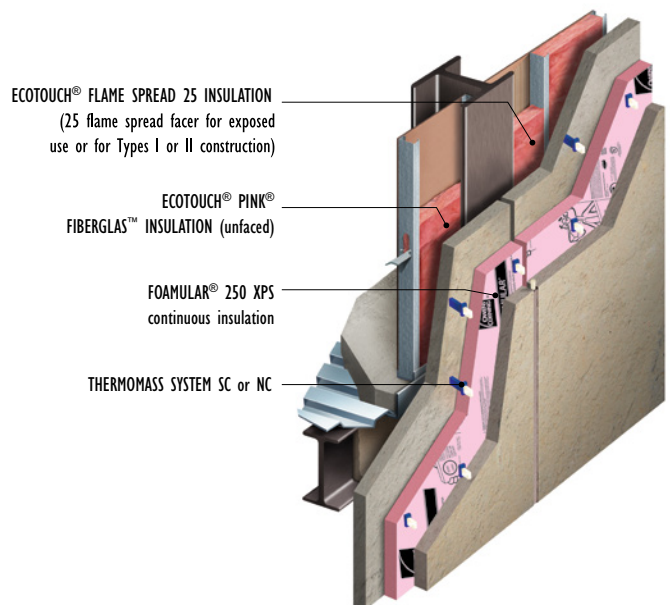

Insulated Precast

CMU, FOAMULAR® XPS, Masonry Veneer

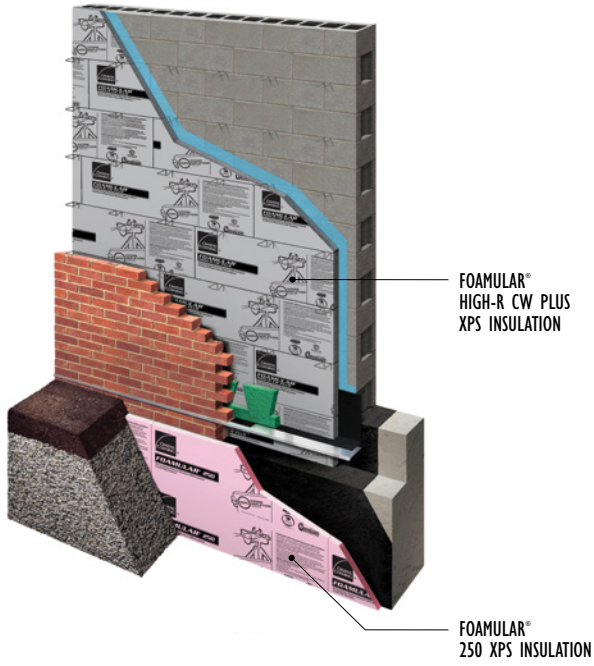

Fluid or Sheet WRB

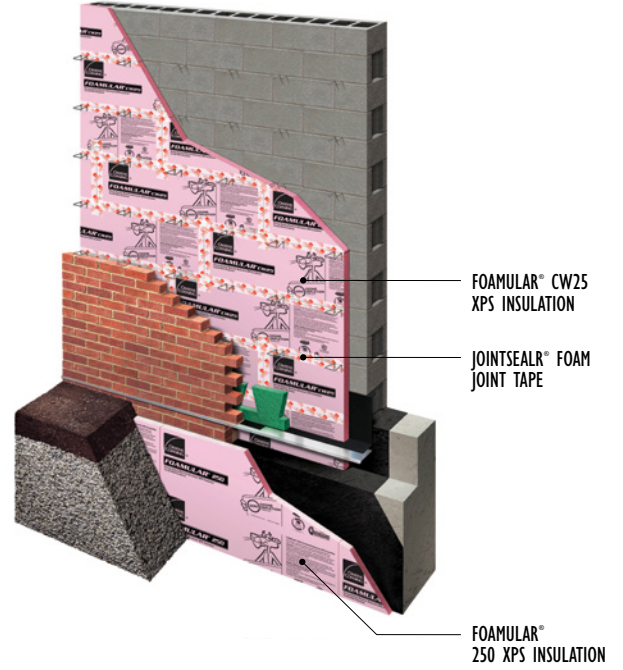

Taped XPS Joints WRB

Steel Stud or CMU, Thermafiber®, Any Cladding

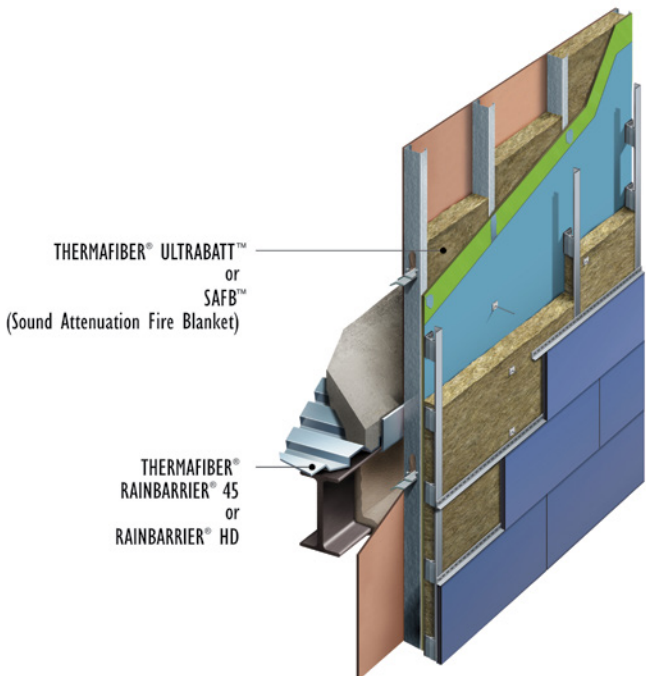

Fluid or Sheet WRB

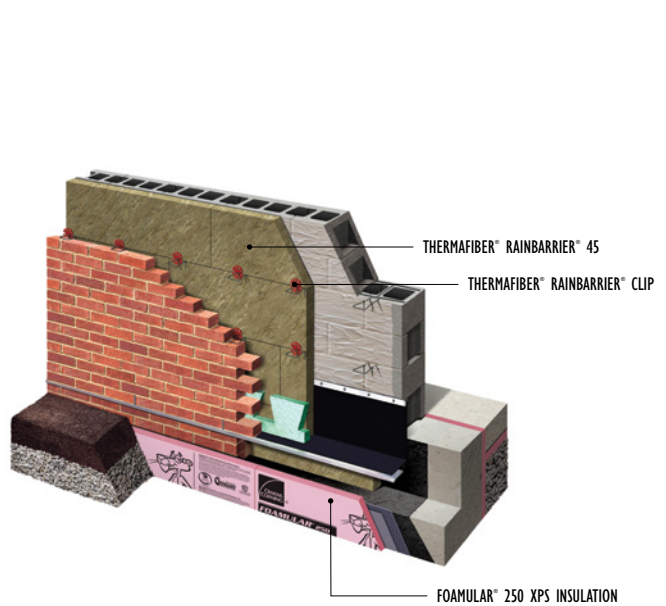

Fluid or Sheet WRB



ENCLOSURE SOLUTIONS

NFPA 285 Accepted Complete Walls

Enclosure Solutions Wall Systems Specification Guide for NFPA 285 Compliant Wall Systems

NFPA 285 accepted components for Enclosure Solutions Wall Systems are provided in Tables 1 and 2.

- Table 1 is for systems using high mass non-combustible exterior cladding such as masonry veneer (brick, CMU, stone, etc.), concrete, stucco, terracotta, etc.
- Table 2 is for systems using combustible or low mass noncombustible exterior cladding such as single skin metal panel, metal composite material (MCM), high density laminate (HDL), etc.

The Tables provide information for approved variations including with and without stud cavity insulation, options for different types of Owens Corning continuous insulation, different types and brands of air/weather resistive barriers, critical detailing for head of openings and other important system details. An NFPA 285 compliant Enclosure Solutions Wall System can be identified by selecting options from each component and detail line item in the appropriate table. See Appendix A for approved Owens Corning® insulation products, Appendix B for accepted air/water barriers, and Appendix C for accepted construction details.

DISCLAIMER: The sole purpose of the information provided in Tables 1, 1a and 2 are to identify certain material options, in assemblies, that have been shown by third party independent testing or engineering analysis, as of the date of this publication, to be compliant with the passing criteria of the NFPA 285 fire test standard. By providing this information, Owens Corning is not making, and specifically disclaims, any recommendations, warranties, or guarantees with respect to any of the listed material options. Complete product data for the Owens Corning products is available in related Owens Corning publications. Product data for non-Owens Corning products, including verification that such products continue to meet the NFPA 285 standards, must be obtained directly from the relevant manufacturer.

Table 1

| For Enclosure Solutions Wall Systems Using HIGH MASS NON-COMBUSTIBLE EXTERIOR CLADDING | |
|---|---|
| Wall Component | Material Options |
| Base Wall System: <i>Select one</i> | |
| | <ul style="list-style-type: none"> ▪ Concrete (cast-in-place or pre-cast) ▪ Concrete Masonry Units ▪ Steel Stud Framing, minimum 3 5/8" depth, minimum 20 gauge, maximum 16 inches on center spacing, with lateral bracing every 4 ft vertically. Cover on the interior with 1 layer of 5/8" thick, Type X, gypsum wallboard. |
| Floorline Firestopping: <i>Select one</i> | |
| <i>If a fire resistance rated floor or floor/ceiling assembly IS required use option 1:</i> | 1. Install an ASTM E2307 tested or evaluated perimeter fire containment joint assembly. Thermafiber® Safing Insulation Thermafiber® Impasse Insulation Hanger System |
| <i>If a fire resistance rated floor assembly IS NOT required use option 2:</i> | 2. Install a mineral wool fire stop, 4 pcf density, attached with Z-clips or equivalent continuously at each floor line and/or in each stud cavity if the stud framing is continuous past the floor line. |
| Stud Cavity Insulation: <i>Select one</i> | |
| <i>Refer to Appendix A for Owens Corning products, properties, sizes, and facer configurations. Complete product data is available in Owens Corning Product Data Sheets at www.ocbuildingspec.com</i> | <ul style="list-style-type: none"> ▪ EcoTouch® Flame Spread 25 Batt Insulation (faced fiber glass) ▪ EcoTouch® Batt Insulation (unfaced fiber glass) ▪ Thermafiber® Ultrabatt™ (faced or unfaced mineral wool) ▪ Any non-combustible insulation (faced or unfaced) ▪ Spray Polyurethane Foam, Demilec Sealaction 500 (0.5 pcf maximum, used only with gypsum exterior sheathing) ▪ None |

Table 1 Continued

| | | |
|---|--|--|
| Exterior Sheathing: <i>Select one</i> | | |
| <i>Options: FOAMULAR® may be installed directly over steel stud framing, with joints sealed with JointSealR® foam joint tape.</i> | <ul style="list-style-type: none"> ▪ None ▪ Gypsum Sheathing, 1/2", exterior grade ▪ Gypsum Sheathing, 5/8", Type X, exterior grade | |
| Air & Water Barrier: <i>Select One</i> | | |
| <p><i>All air & water barriers are to be installed at recommended application rates and in strict accordance with the manufacturer's installation instructions. Verify vapor resistance properties if required.</i></p> <p><i>Options: FOAMULAR® may be installed directly over steel stud framing, with joints sealed with JointSealR® foam joint tape.</i></p> | <ul style="list-style-type: none"> ▪ None ▪ Air/water barrier membrane selected from Appendix B and installed on the base wall behind the continuous insulation (CI) ▪ Owens Corning® JointSealR® Foam Joint Tape applied to the joints of FOAMULAR® XPS continuous insulation ▪ DuPont Tyvek® CommercialWrap applied over continuous insulation ▪ Pactiv GreenGuard® Max Building Wrap applied over continuous insulation | |
| Continuous Insulation (CI): <i>Select one</i> | | |
| <p><i>Refer to Appendix A for Owens Corning products, properties, sizes, and facer configurations. Complete product data is available in Owens Corning Product Data Sheets at www.ocbuildingspec.com</i></p> <p><i>Options: FOAMULAR® may be installed directly over steel stud framing, with joints sealed with JointSealR® foam joint tape.</i></p> | <ul style="list-style-type: none"> ▪ FOAMULAR® 250 XPS ▪ FOAMULAR® High R CW Plus, ▪ FOAMULAR® CW15 XPS ▪ FOAMULAR® CW25 XPS ▪ Thermafiber® Rainbarrier® HD ▪ Thermafiber® Rainbarrier® 45 | <p>ASTM C578 Type IV</p> <p>ASTM C578 Type IV</p> <p>ASTM C578 Type X</p> <p>ASTM C578 Type IV</p> <p>unfaced, minimum 2" thick, mechanically attached per manufacturer's recommendations, continuous over air & weather barrier system if selected</p> <p>unfaced, minimum 2" thick, mechanically attached per manufacturer's recommendations, continuous over air & weather barrier system if selected</p> |
| Exterior Cladding/ Veneer: <i>Select one</i> | | |
| | <ul style="list-style-type: none"> ▪ Brick Veneer: Nominal 4" thick, clay brick. Veneer anchors, standard types, installed maximum 24" o.c. vertically on each stud, or, continuous ladder tie type if CMU backup is utilized. Maximum 2" air space between continuous insulation and brick. ▪ Concrete Masonry Units: Minimum 4" thick. Maximum 2" air space between continuous insulation and CMU. ▪ Concrete Panels: Minimum 2" thick. Maximum 2" air space between continuous insulation and concrete. ▪ EIFS: Polymer Modified (PM) Exterior Insulation Finish Systems, with XPS base. Details as NFPA 285 tested and specified by PM EIFS manufactured. ▪ Insulated Concrete Sandwich Panels: Minimum 2" thick outer face wythe. Maximum 2" air space between continuous insulation and concrete. ▪ Stone Veneer: Minimum 2" thick, limestone or natural stone veneer, or minimum 1 1/2" thick manufactured stone veneer. May use any standard closed joint installation such as ship-lap, etc. ▪ Stucco: Minimum 7/8" thick, exterior cement plaster and lath. Lath mechanically attached. ▪ Terra Cotta Panels: Terra Cotta cladding system, minimum 1 1/4" thick, with closed joint installation such as ship-lap, etc. | |
| Window & Door Openings and Transition Details | | |
| <i>Use any of the details shown in Appendix C as applicable</i> | <ul style="list-style-type: none"> ▪ FOAMULAR® 250 XPS Continuous Insulation ▪ Thermafiber® RainBarrier® Continuous Insulation ▪ Steel Stud (head, jamb, sill) ▪ CMU (head, jamb, sill) ▪ Transitions Between Cladding Types ▪ Flash window, door, and other exterior penetrations with limited amounts of acrylic, asphalt, or butyl-based flashing tape, max. 12" width. | |



ENCLOSURE SOLUTIONS

NFPA 285 Accepted Complete Walls

Underwriters Laboratories Listings for NON-COMBUSTIBLE HIGH MASS EXTERIOR CLADDING

Many Owens Corning® Enclosure Solutions Wall Systems are also listed in the Underwriters Laboratories (UL) On-Line Certifications Directory for NFPA 285 Tested Exterior Wall Systems. See Table 1a, which is an alternate to Table 1 for additional NFPA 285 approved assembly specifications. Established in 2013, the “FWFO” Exterior Wall Systems listing category at UL is relatively new, therefore the number of assemblies and products listed are limited but growing. The International Building Code (IBC) recognizes two methods for determining compliance with NFPA 285:

1. Testing at an “approved agency” in accordance with NFPA 285 which is the source of the assemblies in Table 1a and for some of the assembly options in Table 1. (See IBC Section 2603.5.5) OR,
2. Evaluation and acceptance extended via third party engineering analysis that is extrapolated based on actual testing and performance data which is the source for some of the assembly options in Table 1. (See ICC-ES Acceptance Criteria for Foam Plastic Insulation (AC 12), Section 6.6)

Table 1a

UL Exterior Wall System (EWS) Listings For Non-Combustible High Mass Exterior Cladding

| UL System Listings | Base Wall System | Cladding | Exterior Sheathing | Water Resistive Barrier (WRB) | Continuous Insulation (CI) | Header Fire Stop Detail | Jamb Fire Stop Detail | ASTM E2357 | ASTM E331 |
|--------------------|------------------------------|---|--------------------|---|----------------------------|---|--|------------|-----------|
| EWS0001 | Steel Stud | Brick | Gypsum | ExoAir® 230 | 2.5" FOAMULAR® 250 XPS | Steel w/ Mineral Wool | Steel Flashing | Yes | Yes |
| EWS0002 | Steel Stud | Brick | Gypsum | ExoAir® 230 | 2.5" FOAMULAR® 250 XPS | Steel w/ Mineral Wool | Mineral Wool & Aluminum Flashing/ Frame | Yes | Yes |
| EWS0003 | Steel Stud | Brick | Gypsum | ExoAir® 230 | 2.5" FOAMULAR® 250 XPS | Steel Lintel | Brick Return | Yes | Yes |
| EWS0006 | Steel Stud | Brick | 2.5" | Tape Sealed Joints | 2.5" FOAMULAR® 250 XPS | Steel w/ Mineral Wool | Aluminum Flashing/ Frame | No | No |
| EWS0008 | Steel Stud | Brick | Gypsum | ExoAir® 230 | 4" FOAMULAR® 250 XPS | Steel w/ Mineral Wool | Mineral Wool | Yes | Yes |
| EWS0016 | Steel Stud | Brick | Gypsum | Securock® ExoAir® 430 Panel | 4" FOAMULAR® 250 XPS | Steel Lintel | Mineral Wool & Steel Flashing | Yes | Yes |
| EWS0017 | Steel Stud | Brick | Gypsum | Securock® ExoAir® 430 Panel | 2.5" FOAMULAR® 250 XPS | Steel w/ Mineral Wool | Mineral Wool & Aluminum Flashing/ Frame | Yes | Yes |
| EWS0018 | Steel Stud | Brick | Gypsum | Securock® ExoAir® 430 Panel | 2.5" FOAMULAR® 250 XPS | Steel Lintel | Brick Return | Yes | Yes |
| EWS0021 | Steel Stud or Concrete | Brick, Concrete, CMU, Stone, Terra Cotta, or Stucco | Gypsum | ExoAir® 220 | 4" FOAMULAR® 250 XPS | Steel w/ Mineral Wool & Fire Resistant Wood | Mineral Wool & Fire Retardant Treated Wood | No | No |
| EWS0022 | CMU or Concrete | Brick | N/A | ExoAir® 230 | 4" FOAMULAR® CW25 XPS | Steel w/ Mineral Wool | Mineral Wool | Yes | Yes |
| EWS0023 | CMU | Brick | N/A | JointSealR® Foam Joint Tape FlashSealR® Foam Flashing Tape | 4" FOAMULAR® CW25 XPS | Steel Lintel | Mineral Wool | Yes | Yes |
| EWS0024 | Steel Stud, Concrete, or CMU | Brick, Concrete, CMU, Stone, Terra Cotta, or Stucco | Gypsum | Pecora XL-Perm Ultra VP | 4" FOAMULAR® 250 XPS | Steel w/ Fire Resistant Wood | Fire Retardant Treated Wood & Aluminum Flashing/ Frame | No | No |
| EWS0027 | Steel Stud, Concrete, or CMU | Brick, Concrete, CMU, Stone, Terra Cotta, or Stucco | Gypsum | ExoAir® 130 | 4" FOAMULAR® 250 XPS | Steel w/ Mineral Wool & Fire Resistant Wood | Fire Retardant Treated Wood & Mineral Wool | No | No |



ENCLOSURE SOLUTIONS

NFPA 285 Accepted Complete Walls

Table 2

| For Enclosure Solutions Wall Systems Using COMBUSTIBLE or LOW MASS NON-COMBUSTIBLE EXTERIOR CLADDING | |
|---|--|
| Wall Component | Material Options |
| Base Wall System: <i>Select one</i> | |
| | <ul style="list-style-type: none"> ▪ Concrete (cast-in-place or pre-cast) ▪ Concrete Masonry Units ▪ Steel Stud Framing, minimum 3 5/8" depth, minimum 20 gauge, maximum 16" on center spacing, with lateral bracing every 4 ft vertically. Cover on the interior with 1 layer of 5/8" thick, Type X, gypsum wallboard. |
| Floorline Firestopping: <i>Select one</i> | |
| <i>If a fire resistance rated floor or floor/ceiling assembly IS required use option 1:</i> | 1. Install an ASTM E2307 tested or evaluated perimeter fire containment joint assembly. Thermafiber® Safing Insulation Thermafiber® Impasse Insulation Hanger System |
| <i>If a fire resistance rated floor assembly IS NOT required use option 2:</i> | 2. Install a mineral wool fire stop, 4 pcf density, attached with Z-clips or equivalent continuously at each floor line and/or in each stud cavity if the stud framing is continuous past the floor line. |
| Stud Cavity Insulation: <i>Select one</i> | |
| <i>Refer to Appendix A for Owens Corning products, properties, sizes, and facer configurations. Complete product data is available in Owens Corning Product Data Sheets at www.ocbuildingspec.com</i> | <ul style="list-style-type: none"> ▪ EcoTouch® Flame Spread 25 Batt Insulation (faced fiber glass) ▪ EcoTouch® Batt Insulation (unfaced fiber glass) ▪ Thermafiber® Ultrabatt™ (faced or unfaced mineral wool) ▪ Any non-combustible insulation (faced or unfaced) ▪ Spray Polyurethane Foam, Demilec Sealaction® 500 (0.5 pcf maximum, used only with gypsum exterior sheathing) ▪ None |
| Exterior Sheathing: <i>Select one</i> | |
| | <ul style="list-style-type: none"> ▪ Gypsum Sheathing, 1/2", exterior grade ▪ Gypsum Sheathing, 5/8", Type X, exterior grade |
| Air & Water Barrier: <i>Select One</i> | |
| <i>All air & water barriers are to be installed at recommended application rates and in strict accordance with the manufacturer's installation instructions. Verify vapor resistance properties if required.</i> | <ul style="list-style-type: none"> ▪ None ▪ Air/water barrier membrane selected from Appendix B and installed on the base wall behind the continuous insulation (CI) |
| Continuous Insulation (CI): <i>Select one</i> | |
| <i>Refer to Appendix A for Owens Corning products, properties, sizes, and facer configurations. Complete product data is available in Owens Corning Product Data Sheets at www.ocbuildingspec.com</i> | <ul style="list-style-type: none"> ▪ Thermafiber® Rainbarrier® 45, unfaced, minimum 2" thick, mechanically attached per manufacturer's recommendations, continuous over air & weather barrier system if selected ▪ Thermafiber® Rainbarrier® HD, unfaced, minimum 2" thick, mechanically attached per manufacturer's recommendations, continuous over air & weather barrier system if selected |

Table 2 Continued

Exterior Cladding/ Veneer: *Select one*

- Any Combustible Veneer that has been tested and documented to be NFPA 285 compliant.
- Brick Veneer: Nominal 4" thick, clay brick. Veneer anchors, standard types, installed maximum 24" o.c. vertically on each stud, or, continuous ladder tie type if CMU backup is utilized. Maximum 2" air space between continuous insulation and brick.
- Concrete Masonry Units: Minimum 4" thick. Maximum 2" air space between continuous insulation and CMU.
- Concrete Panels: Minimum 2" thick. Maximum 2" air space between continuous insulation and concrete.
- Fiber Cement or Cement Board Siding: Fastened to the structural backup wall or to Z-furring, girts, or other secondary framing as recommended by the cladding manufacturer.
- Metal Panel: Single skin steel, aluminum, copper, etc, fastened to the structural backup wall or to Z-furring, girts, or other secondary framing or clip system as recommended by the cladding manufacturer.
- Metal Composite Material (MCM): Use any MCM that has been tested and documented to be NFPA 285 compliant. Fastened to the structural backup wall or to Z-furring, girts, or other secondary framing or clip system as recommended by the cladding manufacturer.
- Stone Veneer: Minimum 2" thick, limestone or natural stone veneer, or minimum 1 ½" thick manufactured stone veneer. May use any standard open joint or closed joint installation such as ship-lap, etc.
- Terra Cotta Panels: Terra Cotta cladding system, minimum 1¼" thick, with open or closed joint installation such as ship-lap, etc.

Window & Door Openings and Transition Details

Use any of the details shown in Appendix C as applicable

- Thermafiber® RainBarrier® Continuous Insulation
- Steel Stud (head, jamb, sill)
- CMU (head, jamb, sill)
- Transitions Between Cladding types
- Flash window, door, and other exterior penetrations with limited amounts of acrylic, asphalt, or butyl-based flashing tape, max. 12" width.



ENCLOSURE SOLUTIONS

NFPA 285 Accepted Complete Walls

Appendix A: Owens Corning Approved Insulation Products

The Owens Corning products shown herein can be used in NFPA 285 compliant assemblies as described in Tables 1, 1a, and 2.

FOAMULAR® Extruded Polystyrene Continuous Insulation

| Product Name Application | Thickness (inches) | R-Value | R-Value (180 Day) | R-Value ¹ (LTTR) | Size ² (inches) | Compressive Strength (psi) | ASTM C578 Type | Edge Type |
|---|--------------------|-------------------|-------------------|-----------------------------|----------------------------|----------------------------------|----------------|-------------------------------------|
| | | @ 75° F mean temp | @ 40° F mean temp | @ 75° F mean temp | | | | |
| FOAMULAR® 250 Steel Stud Framing | ¾ | 4.0 | 4.3 | 5.0 | ¾x48x96 | 25 | IV | Square (or T&G up to 2" thick only) |
| | 1 | 5.0 | 5.4 | | 1x48x96 | | | |
| | 1 ½ | 7.5 | 8.1 | 10.6 | 1½ x48x96 | | | |
| | 2 | 10.0 | 10.8 | 13.4 | 2x48x96 | | | |
| | 2 ½ | 12.5 | 13.5 | 16.2 | 2½ x48x96 | | | |
| | 3 | 15.0 | 16.2 | 22.0 | 3x48x96 | | | |
| | 4 | 20.0 | 21.6 | | 4x48x96 | (FOAMULAR® 250 also in 24" wide) | | |
| FOAMULAR® CW15 Concrete Masonry | 1 | 5.0 | 5.4 | 5.0 | 1x16 x96 | 15 | X | Square |
| | 1 ½ | 7.5 | 8.1 | | 1½ x16 x96 | | | |
| | 2 | 10.0 | 10.8 | 10.6 | 2x16 x96 | | | |
| | 2 ½ | 12.5 | 13.5 | 13.4 | 2½ x16 x96 | | | |
| | 3 | 15.0 | 16.2 | 16.2 | 3 x16 x96 | | | |
| FOAMULAR® CW25 Concrete Masonry | 1 | 5.0 | 5.4 | 5.0 | 1x16 x96 | 25 | IV | Square |
| | 1 ½ | 7.5 | 8.1 | | 1½ x16x96 | | | |
| | 2 | 10.0 | 10.8 | 10.6 | 2x16 x96 | | | |
| | 2 ½ | 12.5 | 13.5 | 13.4 | 2½ x16 x96 | | | |
| | 3 | 15.0 | 16.2 | 16.2 | 3x16 x96 | | | |
| FOAMULAR® High R CW Plus Concrete Masonry | 1 ¾ | 10.0 | 10.8 | 10.3 | 1¾ x16x96 | 25 | IV | Square |
| | 2 ⅝ | 12.0 | 13.0 | 12.5 | 2⅝ x16x96 | | | |
| | 3 | 17.0 | 18.4 | | 3x16 x96 | | | |

- R-values vary depending on many factors including the mean temperature at which the test is conducted, and the age of the sample at the time of testing. Because rigid foam plastic insulation products are not all aged in accordance with the same standards, it is useful to publish comparison R-value data. The R-value for FOAMULAR® XPS is provided from testing at two mean temperatures, 40°F and 75°F, and from two aging (conditioning) techniques, 180 day real-time aging (as mandated by ASTM C578), and a method of artificially accelerating aging sometimes called "Long Term Thermal Resistance" (LTTR, CAN/ULC S770). The R-value at 180 day real-time aged, and 75°F mean temperature, is commonly used to compare products. It is recommended that the specifier verify testing and conditioning methods with the manufacturer before comparing the R-value of rigid foam plastic insulation products.
- Availability may vary depending on sizes, edge configuration, and/or region. Some items are made to order. Check with your local FOAMULAR® representative for specific information.

JointSealR® Foam Joint Tape

| Function | Roll Width (inches) | Roll Length (feet) | Backer |
|--|---------------------|--------------------|---------|
| Sealing FOAMULAR® XPS rigid board joints | 3.5 | 90 | Acrylic |

EcoTouch® Fiberglas™ Insulation

| Product Name | Thickness (inches) | R-Value (@ 75° F Mean Temp.) | Perm Rating (Maximum) | Width (Inches) | Length (Inches) | ASTM C665 |
|--|-----------------------|---------------------------------|--------------------------|--|--------------------|---|
| EcoTouch® PINK® FIBERGLAS™ (Unfaced) | 3 1/2 | 11 | N/A | 16 or 24 (Specify full width for steel stud) | 48 or 96 | Type 1 |
| | 3 1/2 | 13 | | | 48 or 96 | |
| | 3 1/2 | 15 | | | 96 | |
| | 6 1/4 | 19 | | | 48 or 96 | |
| | 5 1/2 | 21 | | | 96 | |
| EcoTouch® Flame Spread 25 (Faced) | 3 1/2 | 11 | 0.02 | 16 or 24 (Specify full width for steel stud) | 96 | FSK (Foil) Faced: Type III, Class A or PSK (White) Faced: Type II, Class A |
| | 3 1/2 | 13 | | | 96 | |
| | 6 1/4 | 19 | | | 96 | |
| | 9 1/2 | 30 | | | 48 | |

Thermafiber® Mineral Wool Insulation

| Product Name | Thickness (inches) | R-Value (@ 75° F mean temp) | Perm Rating (Maximum) | Width (inches) | Length (inches) | ASTM C665 |
|---|-----------------------|--------------------------------|---|-------------------|--------------------|--|
| RainBarrier® 45 RainBarrier® HD [Exterior Cavity Continuous Insulation (Unfaced)] | 1" | 4.3 | 50 | 16, 24 or 36 | 48 or 60 | Type I |
| | 1.5" | 6.5 | | | | |
| | 2" | 8.7 | | | | |
| | 2.5" | 10.9 | | | | |
| | 3" | 13 | | | | |
| | 3.5" | 15.2 | | | | |
| | 4" | 17.4 | | | | |
| | 4.5" | 19.6 | | | | |
| | 5" | 21.7 | | | | |
| | 5.5" | 23.9 | | | | |
| Safing [FireStopping Insulation (Unfaced or Faced)] | 1" | 4.2 | 50 (Unfaced) or 0.02 (Foil Faced) | 16, 24 or 36 | 48 or 60 | Type I (Unfaced) or Type III, Class A (Foil Faced) |
| | 1.5" | 6.3 | | | | |
| | 2" | 8.3 | | | | |
| | 2.5" | 10.4 | | | | |
| | 3" | 12.5 | | | | |
| | 3.5" | 14.6 | | | | |
| | 4" | 16.7 | | | | |
| | 4.5" | 18.8 | | | | |
| | 5" | 20.8 | | | | |
| | 5.5" | 22.9 | | | | |
| UltraBatt™ [Exterior Wall Batt Insulation (Unfaced or Faced)] | 2.5" | 10 | 50 (Unfaced) or 0.02 (Foil Faced) | 15, 16, 23, or 24 | 47 or 48 | Type I (Unfaced) or Type III, Class A (Foil Faced) |
| | 3.5" | 15 | | | | |
| | 5.5" | 23 | | | | |
| | 6" | 24 | | | | |
| | 7.1" | 30 | | | | |



ENCLOSURE SOLUTIONS

NFPA 285 Accepted Complete Walls

Appendix B: Air/Water Barrier Membrane Options

The products listed in Tables B-1 and B-2 are approved as described in Specification Guide Tables 1 and 2 for use in Owens Corning's NFPA 285 compliant Enclosure Solutions Wall Systems.

Use of Tables B-1 and B-2

Select the appropriate class air/water barrier system for the project need:

- Table B-1 for Class I vapor retarding performance
- Table B-2 for Class II or III vapor retarding performance

Definitions: (International Building Code, Section 1405.3.3, Material Vapor Retarder Class)

Vapor Permeable Membranes have a water vapor permeance rating of 5 perms or greater when tested in accordance with ASTM E96, desiccant method, Procedure A. Vapor Retarding Membranes limit the amount of water vapor that passes through a material when tested in accordance with ASTM E96, desiccant method, Procedure A. Permeance Classifications are defined as follows:

Class I: ≤ 0.1 perm

Class II: > 0.1 perm ≤ 1.0 perm

Class III: > 1.0 perm ≤ 10 perm

The tables are also organized by type of system, either fluid applied, mechanically attached sheet, or self adhering sheet. Refer to the membrane manufacturer for specific product specifications, technical data, and installation instructions.*

For additional air/water barrier code compliance information consult the following references:

- International Building Code, Section 1404.2, Water Resistive Barrier
- ANSI/ASHRAE/IES Standard 90.1, Energy Standard for Buildings Except Low Rise Residential Buildings, Section 5.4.3.1.3, (Air Barrier Design) Acceptable Materials and Assemblies
- International Energy Conservation Code, Section C-402.5.1.2.2, Assemblies (Air Barrier Compliance Options)

Table B-1, Class I Vapor Retarder*

| Fluid-Applied Membranes | |
|---------------------------------------|---|
| BASF | Enershield® I |
| Carlisle | Barritech™ NP |
| Grace Construction Products | Perm-A-Barrier® NPL |
| Henry | Air-Bloc® 32MR |
| Henry | Air-Bloc® 21FR (used as an adhesive for rigid insulation) |
| Henry | Air-Bloc® 33MR |
| Hohmann & Barnard | Enviro-Barrier™ |
| Polyguard Products | Airlok Flex® |
| PROSOCO | R-Guard® VB |
| Tremco | ExoAir® 130 |
| W.R. Meadows | Air-Shield™ LSR |
| Mechanically Attached Sheet Membranes | |
| NA | |
| Self-Adhered Sheet Membranes | |
| Carlisle | CCW-705FR |
| 3M | Self-Adhered Air and Vapor Barrier 3015 |
| Grace Construction Products | Perm-A-Barrier® Aluminum Wall |
| Henry | Metal Clad™ |
| Henry | Foilskin® |

Table B-2, Class II, III, or Higher Perm Vapor Retarder*

| Fluid-Applied Membranes | |
|---------------------------------------|---|
| BASF | Enershield® HP |
| Carlisle | Barritech™ VP |
| Dryvit | Backstop® NT |
| Dupont™ | DuPont™ Tyvek® Fluid Applied Weather Barrier |
| Grace Construction Products | Perm-A-Barrier® VPL |
| Grace Construction Products | Perm-A-Barrier® VPL LT |
| Henry | Air-Bloc® 17MR |
| Henry | Air-Bloc® 31MR |
| Henry | Air-Bloc® 33MR |
| Hohmann & Barnard | Enviro-Barrier™ VP |
| Momentive Performance Materials | GE SEC2500 SilShield AWB |
| Momentive Performance Materials | GE SEC2600 SilShield AWB |
| Momentive Performance Materials | Elemax 2600 |
| Pecora Corporation | XL-Perm Ultra VP |
| Polyguard Products | Airlok Flex® WG |
| Polyguard Products | Airlok Flex® VP |
| PROSOCO | R-Guard® CAT 5 |
| PROSOCO | R-Guard® CAT 5 Rain Screen |
| PROSOCO | R-Guard® Spray Wrap MVP |
| Sto Corp | Sto Gold Coat® with StoGuard Fabric |
| Sto Corp | Sto Emerald Coat® with StoGuard Fabric |
| Sto Corp | Sto ExtraSeal™ with StoGuard Mesh (Used as adhesive for rigid insulation) |
| STS Coatings | Wall Guardian™ FW-100A |
| Tremco | ExoAir® 230 |
| Tremco | Securock® ExoAir® 430 (Liquid membrane factory applied to USG Securock® Sheathing) |
| W.R. Meadows | Air-Shield™ LMP (Gray) |
| W.R. Meadows | Air-Shield™ LMP (Black) |
| W.R. Meadows | Air-Shield™ TMP |
| Mechanically Attached Sheet Membranes | |
| Cosella-Dörken | Delta®-Fassade S |
| Cosella-Dörken | Delta®-Foxy |
| Cosella-Dörken | Delta®-Foxy Plus |
| Cosella-Dörken | Delta®-Maxx Plus |
| Cosella-Dörken | Delta®-Vent S/Plus |
| Dow Chemical | WeatherMate™ |
| Dow Chemical | WeatherMate™ Plus |
| Dupont™ | DuPont™ Tyvek® CommercialWrap® |
| Dupont™ | DuPont™ Tyvek® CommercialWrap® D |
| Dupont™ | DuPont™ Tyvek® ThermaWrap™ |
| Kingspan Pactiv | C500 |
| Kingspan Pactiv | C2000 |
| Kingspan Pactiv | Raindrop® 3D |
| Kingspan Pactiv | GreenGuard Max™ |
| Kingspan Pactiv | GreenGuard VW |
| VaproShield | RevealShield™ |
| VaproShield | WallShield® |
| VaproShield | WrapShield® |
| Self-Adhered Sheet Membranes | |
| Grace Construction Products | Perm-A-Barrier® VPS |
| Henry | BlueskinVP™ 160 |
| VaproShield | RevealShield SA™ |
| VaproShield | WrapShield® SA RS Rain Screen |
| VaproShield | WrapShield® SA |

1. * All information in Tables A-1 and A-2 is as published by the manufacturer as of April 2016. It is recommended that the product information shown be verified to be current before including it in project specifications.



ENCLOSURE SOLUTIONS

NFPA 285 Accepted Complete Walls

Appendix C:

Enclosure Solutions Wall Systems

Construction Details for NFPA 285 Compliant Wall Systems

Successful NFPA 285 performance is highly dependent on proper detailing around openings (windows, doors, heads, jambs, sills) to ensure that fire and heat does not penetrate into cavity spaces behind the exterior cladding. These details vary depending on the type of insulation used (combustible or non-combustible), the air/water barrier, and the type of cladding (high mass non-combustible, combustible, or low mass non-combustible). The details provided have successfully passed NFPA 285¹ fire evaluation.² CAD files can be found at www.owenscorning.com/enclosure.

¹NFPA 285, Standard Fire Test Method for Evaluation of Fire Propagation Characteristics of Exterior Non-Load Bearing Wall Assemblies Containing Combustible Components; National Fire Protection Association, 1 Batterymarch Park, Quincy, Massachusetts 02169

²Some details provided have been tested in accordance with NFPA 285, while others have been evaluated and acceptance extended via third party engineering analysis in accordance with ICC-ES Acceptance Criteria for Foam Plastic Insulation (AC 12), Section 6.6.

DISCLAIMER: The details provided in Appendix C are schematically correct to ensure proper fire stopping/closure of exterior wall openings. The Architect of Record is responsible for assessing the suitability of each detail for use on a given project and for adapting it accordingly. If questions arise regarding proposed modifications, please contact Owens Corning for consultation. These details are judged to meet the passing criteria of the consensus standard NFPA 285 based on available test data and engineering analysis. However, because actual fire incidents vary greatly, by providing these details, Owens Corning is not making, and specifically disclaims, any recommendations, warranties, or guarantees with respect to performance in an actual fire incident.

Appendix C Table of Contents

| Detail Number | FOAMULAR® 250 XPS CONTINUOUS INSULATION DETAILS | FOAMULAR® 250 XPS as Air Barrier |
|---------------|--|---|
| | Fluid or Sheet Air Barrier | |
| | STEEL STUD HEAD | STEEL STUD HEAD |
| 01 | FOAMULAR® 250 XPS ci with steel angle cavity closure | 18 FOAMULAR® 250 XPS ci with steel angle cavity closure |
| 02 | FOAMULAR® 250 XPS ci with FRTW blocking & loose angle cavity closure | 19 FOAMULAR® 250 XPS ci with FRTW blocking & loose angle cavity closure |
| | STEEL STUD JAMB | STEEL STUD JAMB |
| 03 | FOAMULAR® 250 XPS ci with Thermafiber® Safing cavity closure | 20 FOAMULAR® 250 XPS ci with Thermafiber® Safing cavity closure |
| 04 | FOAMULAR® 250 XPS ci with FRTW cavity closure | 21 FOAMULAR® 250 XPS ci with FRTW cavity closure |
| 05 | FOAMULAR® 250 XPS ci with masonry return cavity closure | 22 FOAMULAR® 250 XPS ci with masonry return cavity closure |
| | STEEL STUD SILL | STEEL STUD SILL |
| 06 | FOAMULAR® 250 XPS ci with Thermafiber® Safing | 23 FOAMULAR® 250 XPS ci with Thermafiber® Safing |
| 07 | FOAMULAR® 250 XPS ci with masonry return & wash cavity closure | 24 FOAMULAR® 250 XPS ci with masonry return & wash cavity closure |
| | CMU HEAD | |
| 08 | FOAMULAR® 250 XPS ci with steel angle cavity closure | |
| 09 | FOAMULAR® 250 XPS ci with Thermafiber® & loose angle cavity closure | |
| | CMU JAMB | |
| 10 | FOAMULAR® 250 XPS ci with Thermafiber® Safing cavity closure | |
| 11 | FOAMULAR® 250 XPS ci with FRTW blocking cavity closure | |
| 12 | FOAMULAR® 250 XPS ci with masonry return & wash cavity closure | |
| | CMU SILL | |
| 13 | FOAMULAR® 250 XPS ci with Thermafiber® Safing | |
| 14 | FOAMULAR® 250 XPS ci with masonry return & wash cavity closure | |
| | STUCCO CLADDING | |
| 15 | FOAMULAR® 250 with head backwrap | |
| 16 | FOAMULAR® 250 with jamb backwrap | |
| 17 | FOAMULAR® 250 with sill & wash backwrap | |

Appendix C Table of Contents Continued

TRANSITION HEAD, STEEL STUD

- 25 MCM w/ Thermafiber® (mineral wool) – to – masonry w/ FOAMULAR® XPS
- 26 MCM w/ Thermafiber® (mineral wool) – to – masonry w/ Thermafiber®

TRANSITION JAMB, STEEL STUD

- 27 MCM w/ Thermafiber® (mineral wool) – to – masonry w/ FOAMULAR® XPS
- 28 MCM w/ Thermafiber® (mineral wool) – to – masonry w/ Thermafiber®

TRANSITION SILL, STEEL STUD

- 29 MCM w/ Thermafiber® (mineral wool) – to – masonry w/ FOAMULAR® XPS
- 30 MCM w/ Thermafiber® (mineral wool) – to – masonry w/ Thermafiber®

TRANSITION HEAD, CMU

- 31 MCM w/ Thermafiber® (mineral wool) – to – masonry w/ FOAMULAR® XPS
- 32 MCM w/ Thermafiber® (mineral wool) – to – masonry w/ Thermafiber®

TRANSITION JAMB, CMU

- 33 MCM w/ Thermafiber® (mineral wool) – to – masonry w/ FOAMULAR® XPS
- 34 MCM w/ Thermafiber® (mineral wool) – to – masonry w/ Thermafiber®

TRANSITION SILL, CMU

- 35 MCM w/ Thermafiber® (mineral wool) – to – masonry w/ FOAMULAR® XPS
- 36 MCM w/ Thermafiber® (mineral wool) – to – masonry w/ Thermafiber®

THERMAFIBER® RAINBARRIER® MINERAL WOOL CONTINUOUS INSULATION DETAILS

STEEL STUD HEAD

- 37 Thermafiber® RainBarrier® ci with steel angle cavity closure
- 38 Thermafiber® RainBarrier® ci with FRTW blocking & loose angle cavity closure

STEEL STUD JAMB

- 39 Thermafiber® RainBarrier® ci with window frame cavity closure
- 40 Thermafiber® RainBarrier® ci with FRTW cavity closure
- 41 Thermafiber® RainBarrier® ci with masonry return cavity closure

STEEL STUD SILL

- 42 Thermafiber® RainBarrier® ci with window frame cavity closure
- 43 Thermafiber® RainBarrier® ci with masonry return & wash cavity closure

CMU HEAD

- 44 Thermafiber® RainBarrier® ci with steel angle cavity closure
- 45 Thermafiber® RainBarrier® ci with window frame & loose angle cavity closure

CMU JAMB

- 46 Thermafiber® RainBarrier® ci with window frame cavity closure
- 47 Thermafiber® RainBarrier® ci with FRTW cavity closure
- 48 Thermafiber® RainBarrier® ci with masonry return cavity closure

CMU SILL

- 49 Thermafiber® RainBarrier® ci with window frame cavity closure
- 50 Thermafiber® RainBarrier® ci with masonry return & wash cavity closure

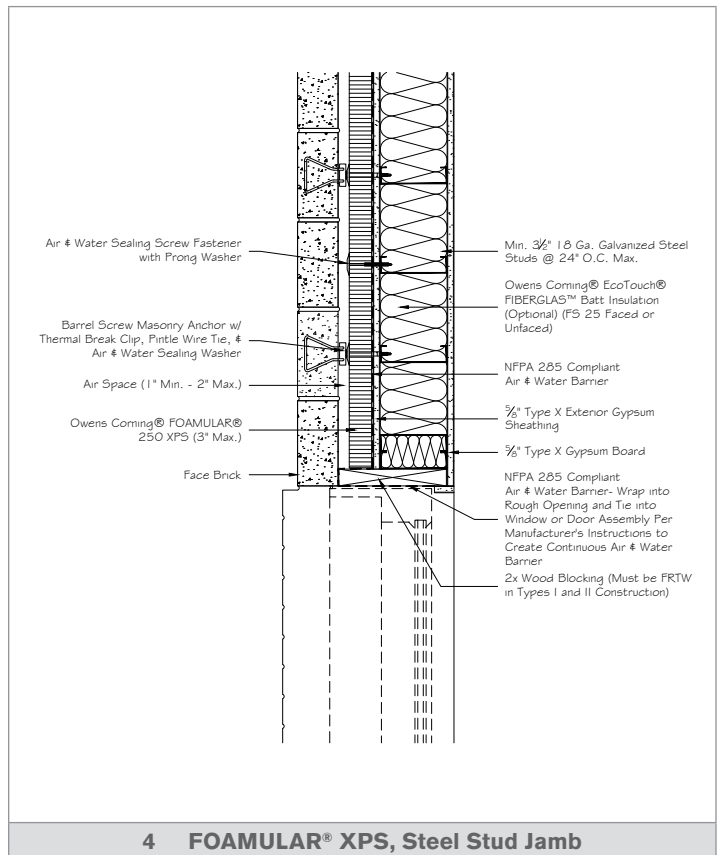
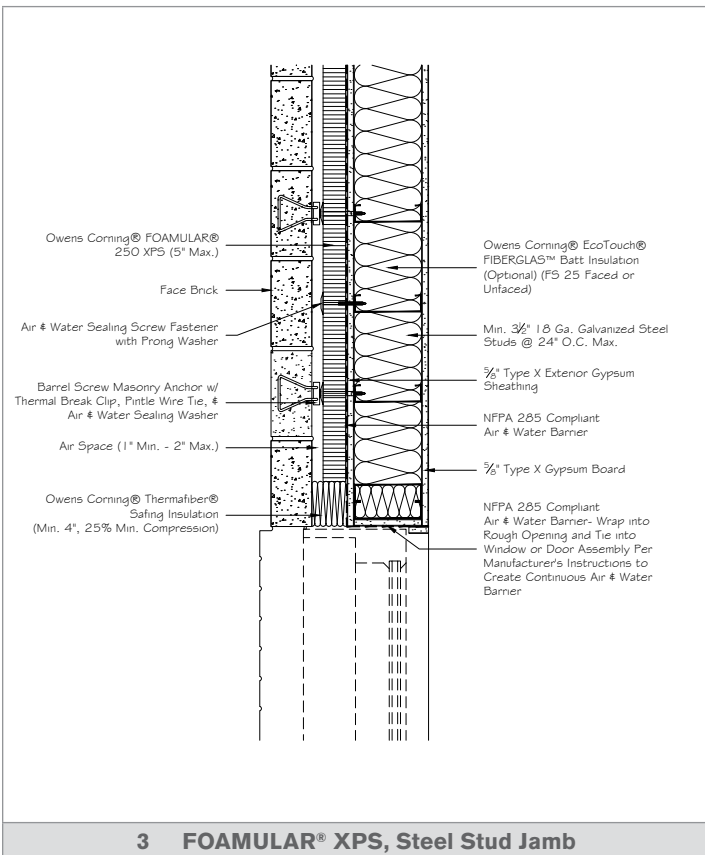
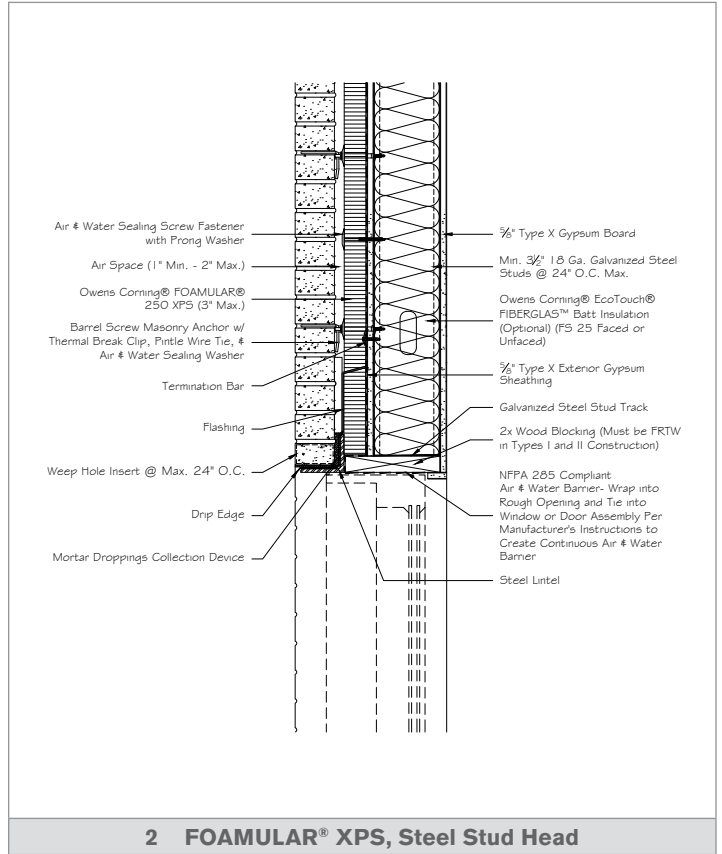
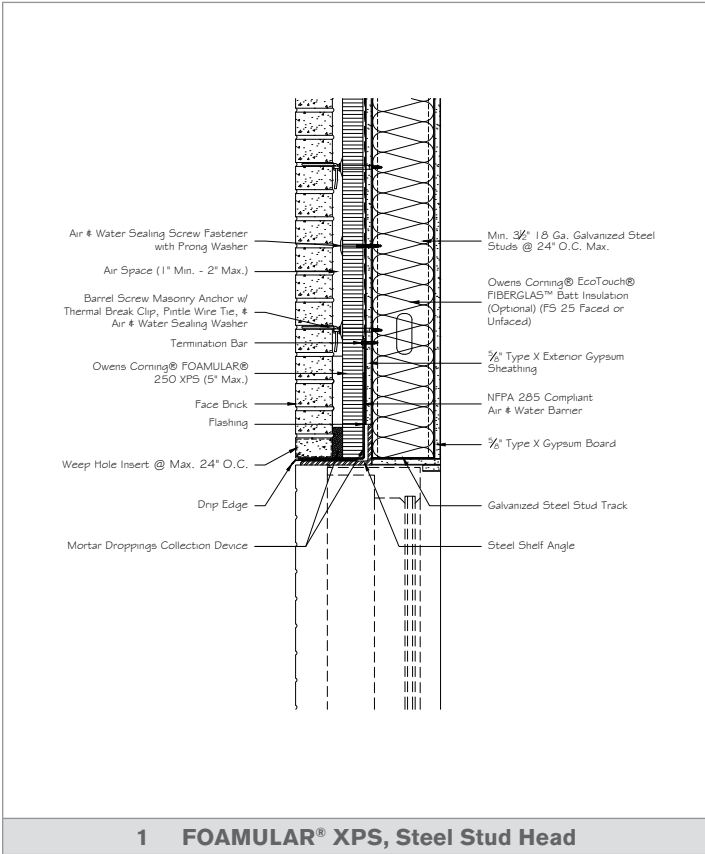

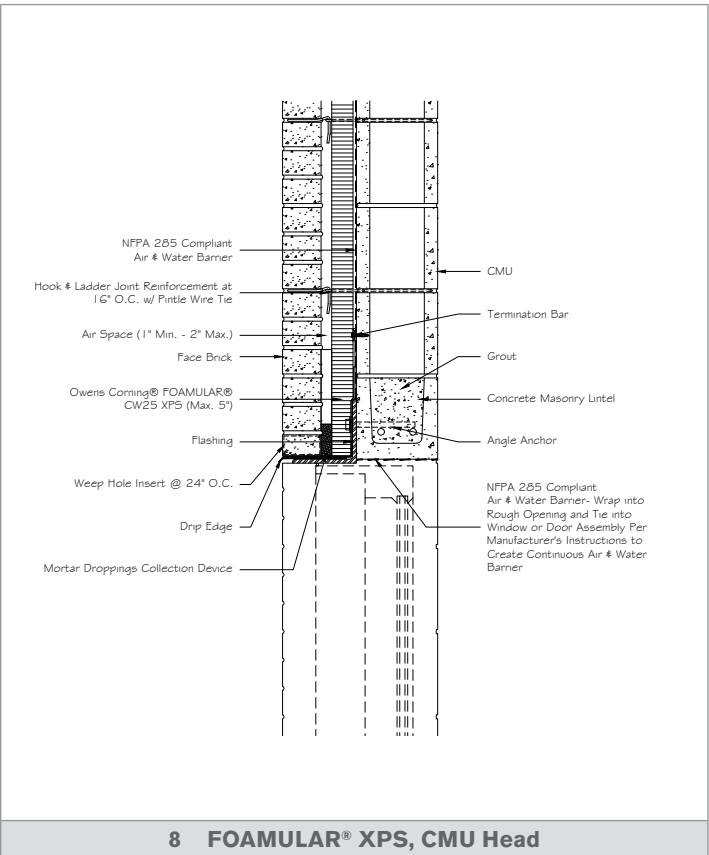
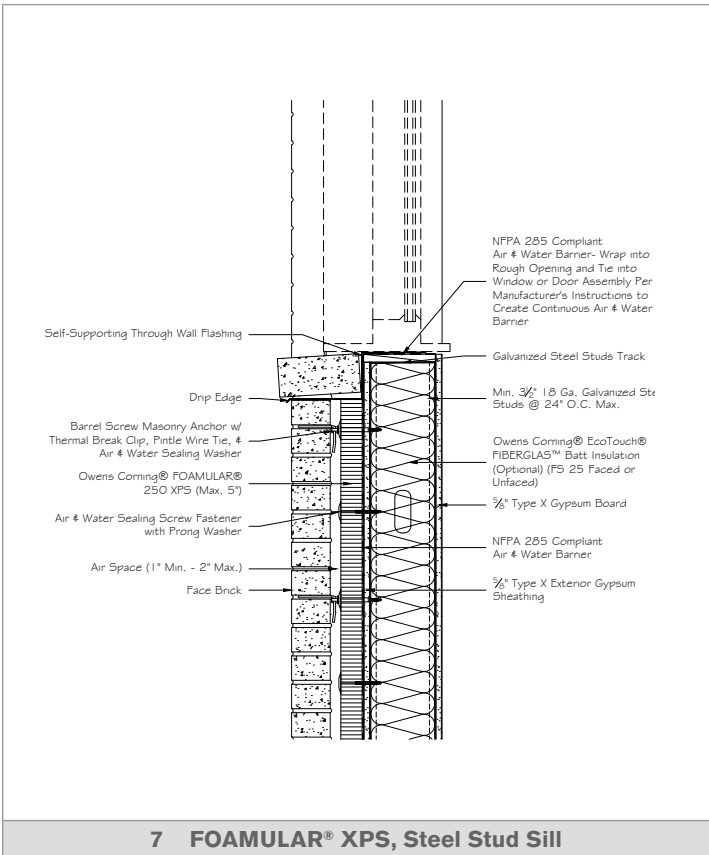
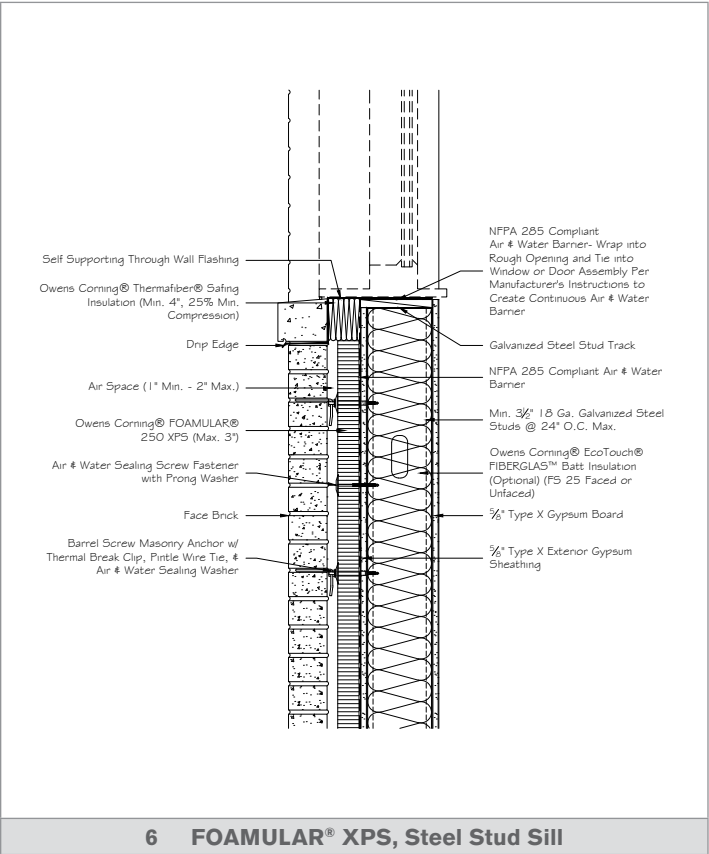
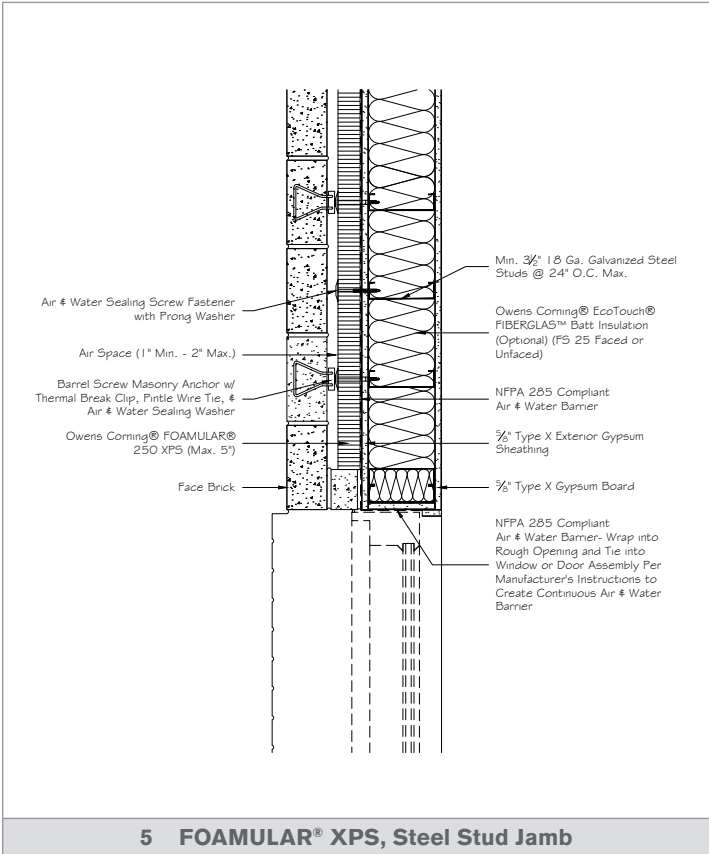

ENCLOSURE SOLUTIONS

NFPA 285 Accepted Complete Walls

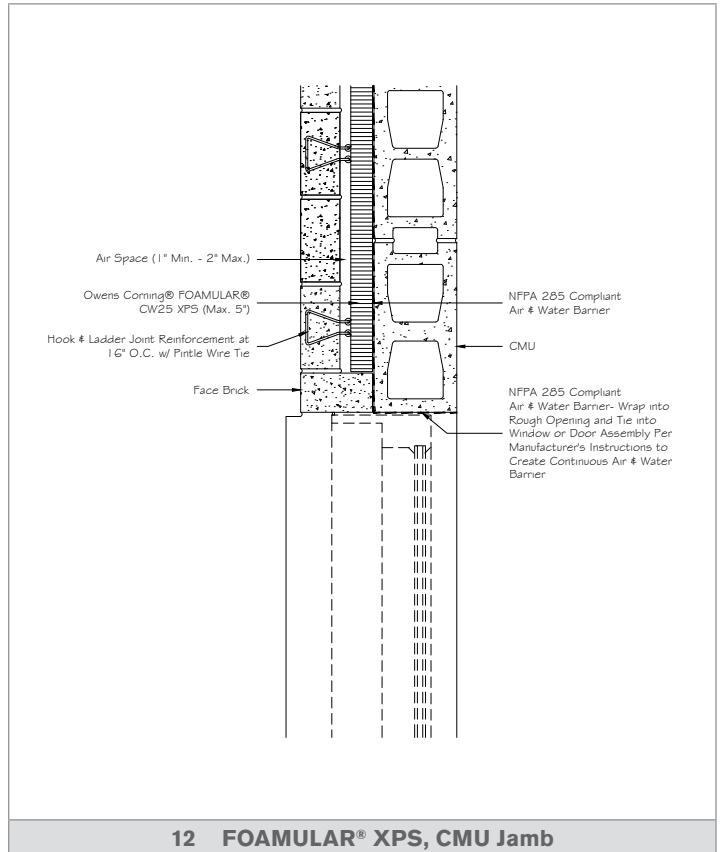
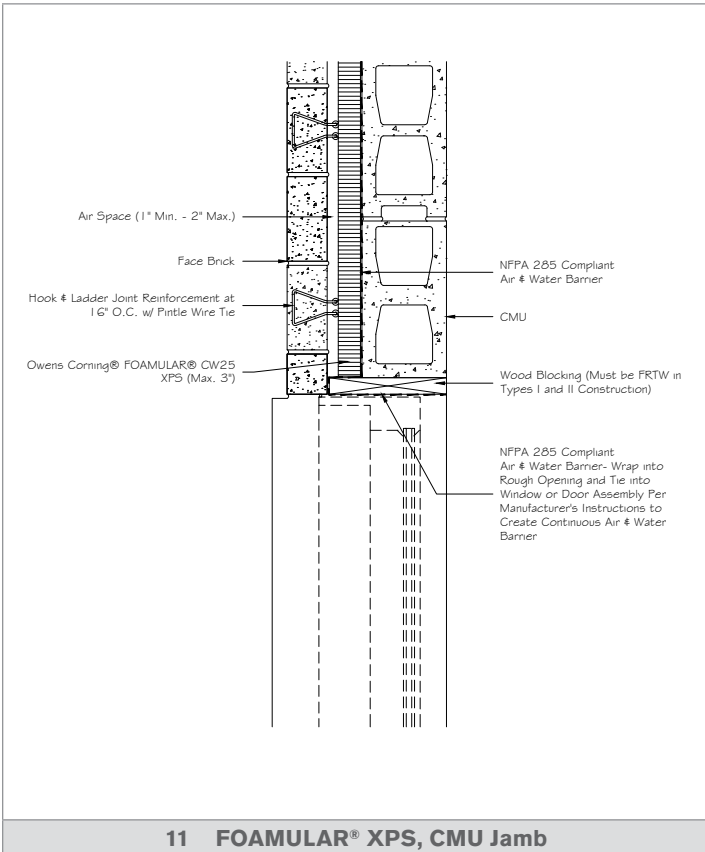
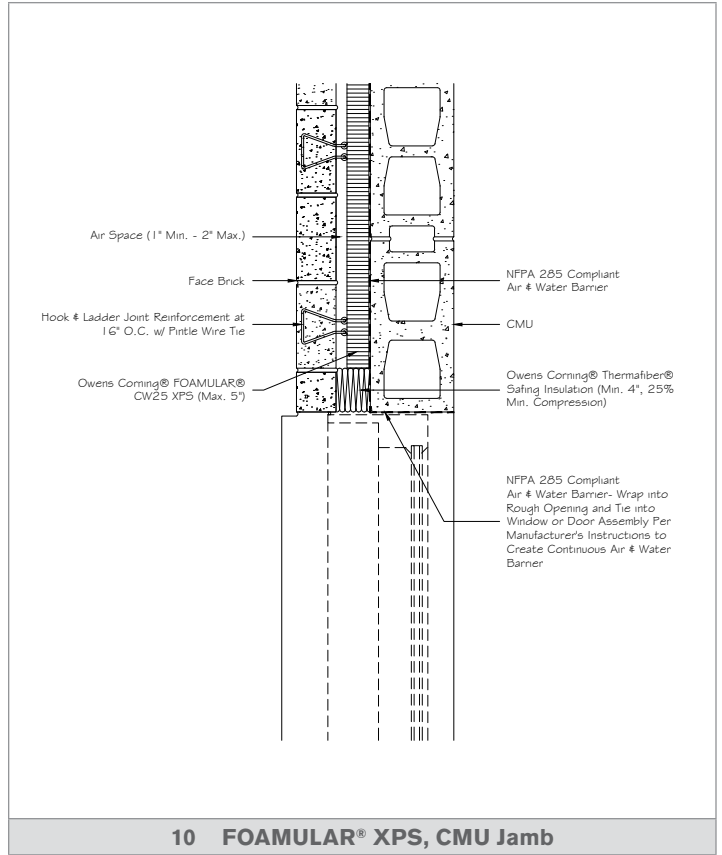
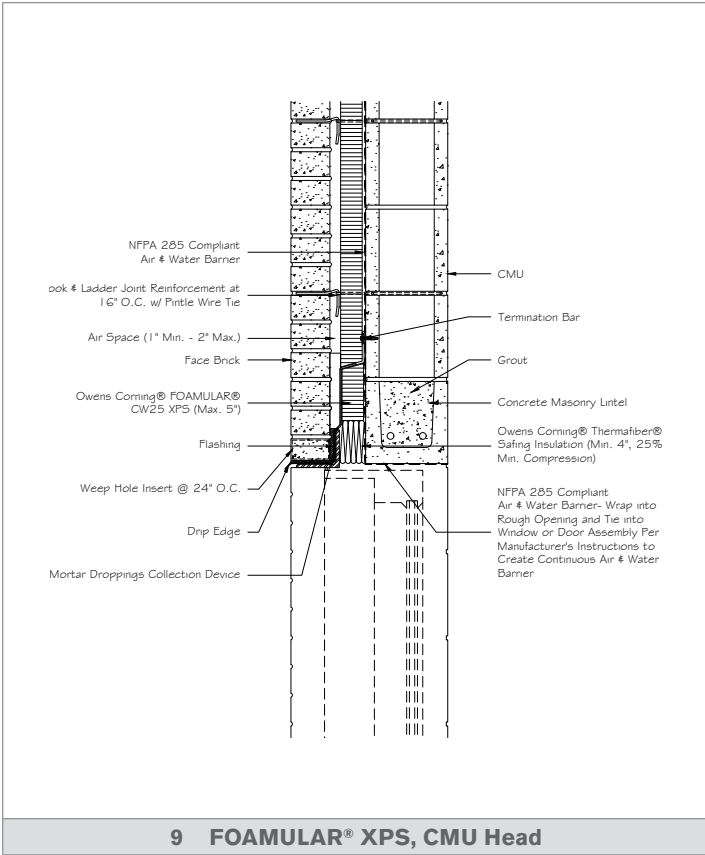

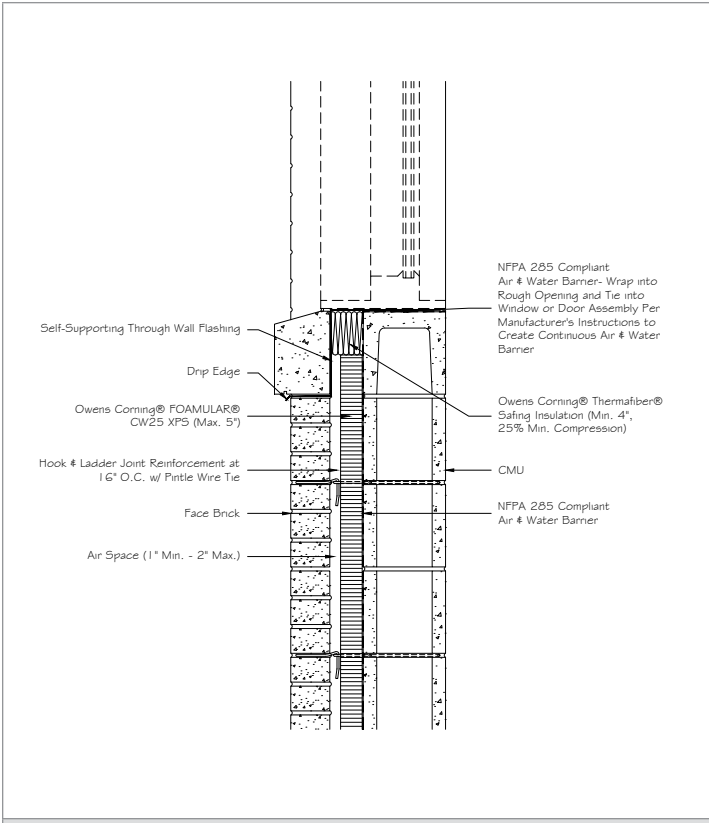

13 FOAMULAR® XPS, CMU Sill

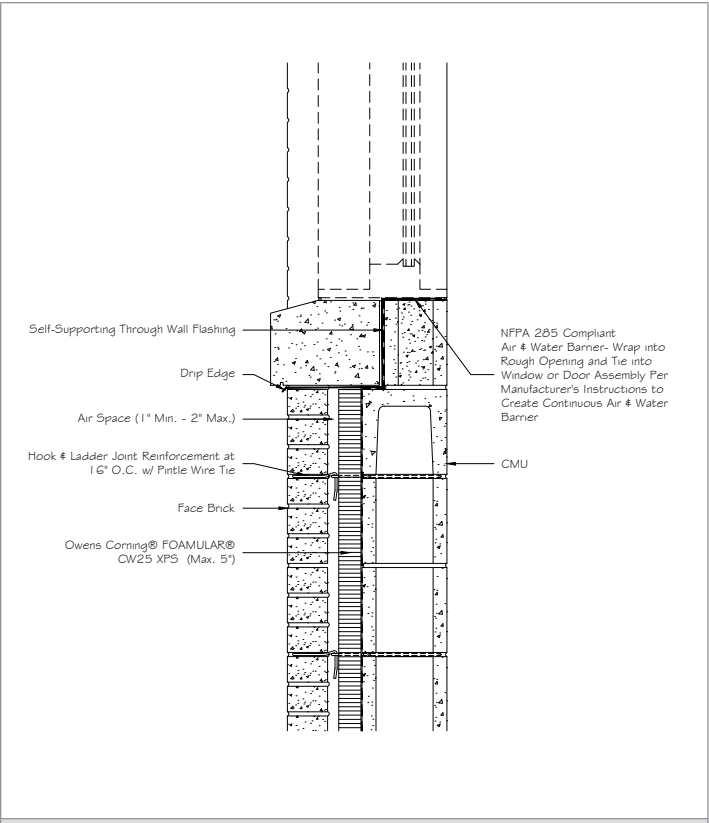

14 FOAMULAR® XPS, CMU Sill

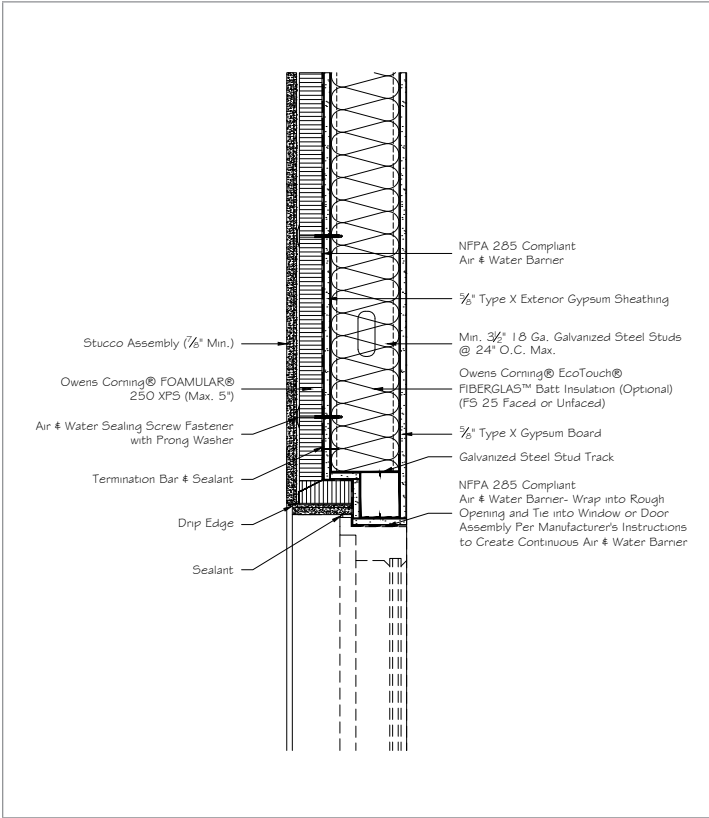

15 FOAMULAR® XPS, Stucco Head

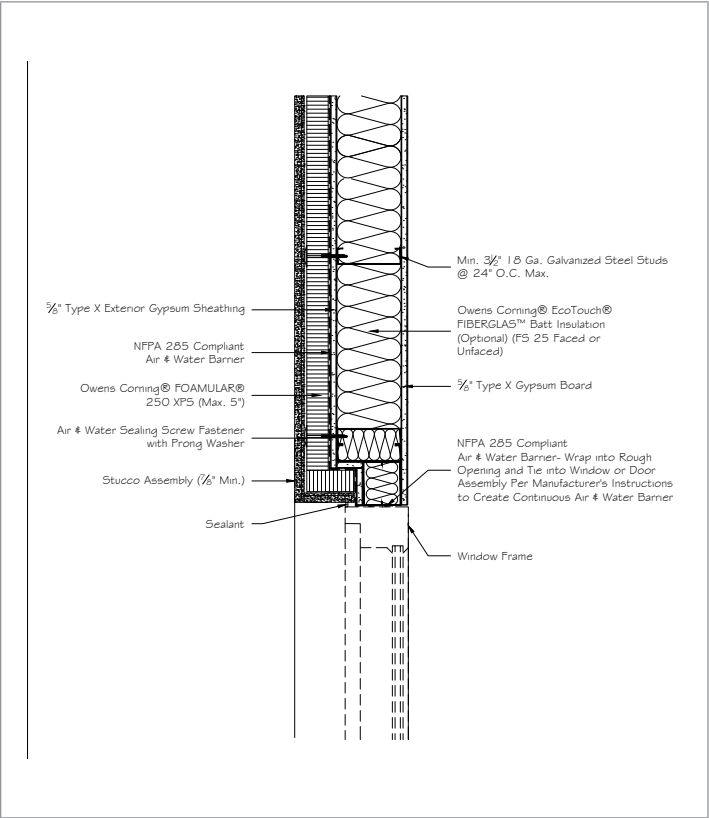

16 FOAMULAR® XPS, Stucco Jamb

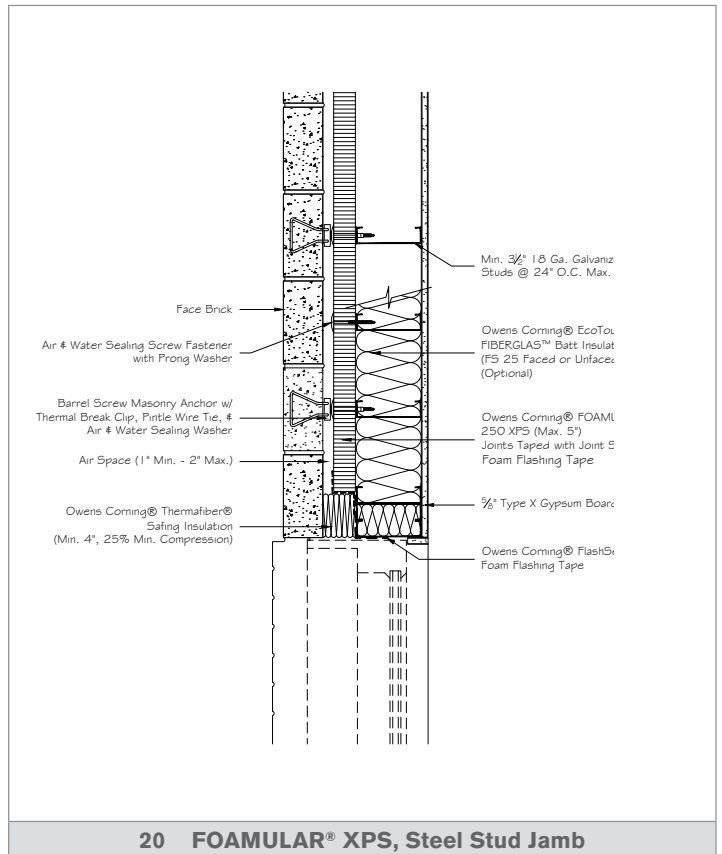
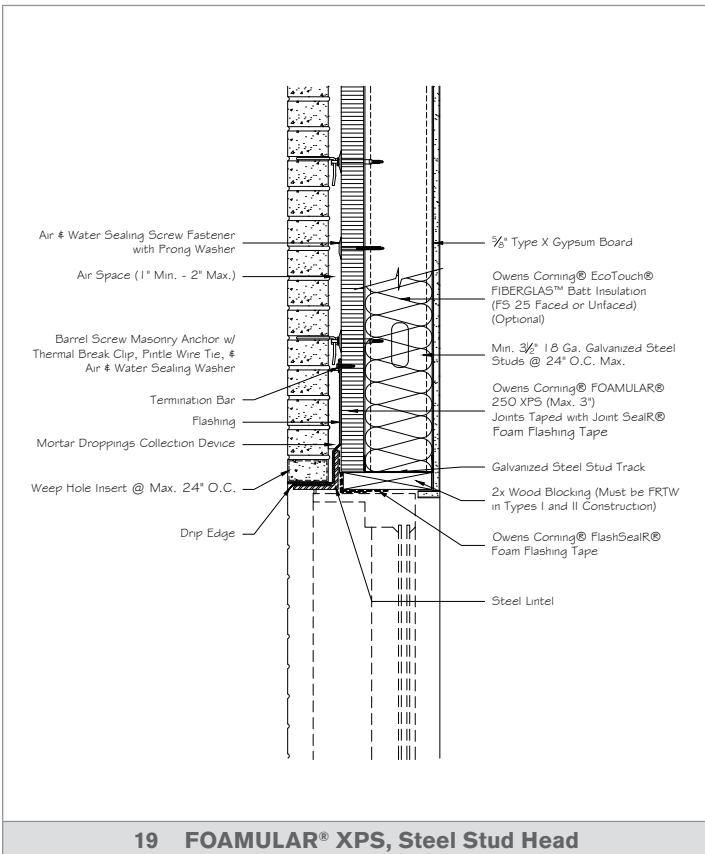
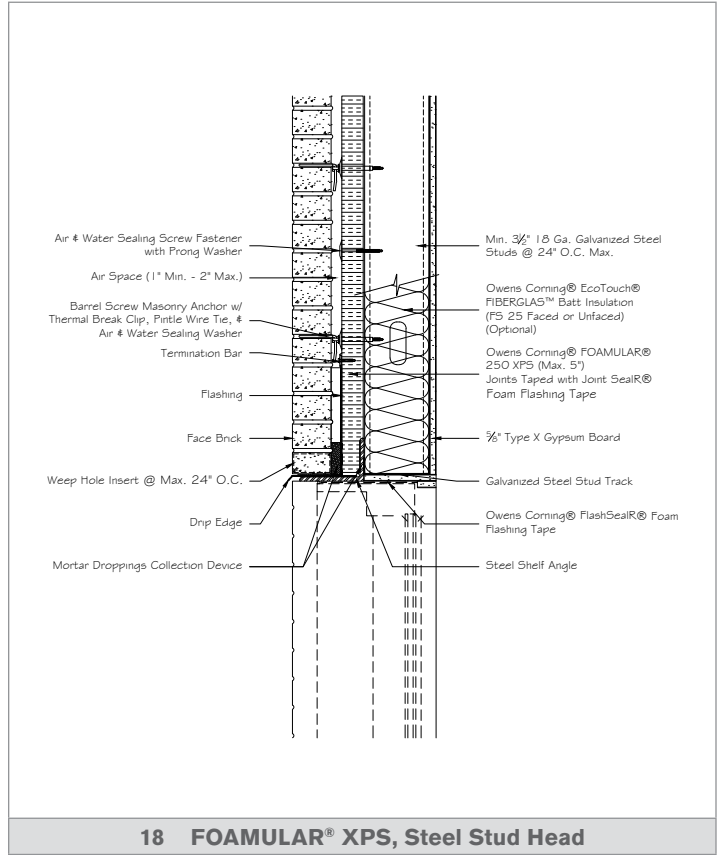
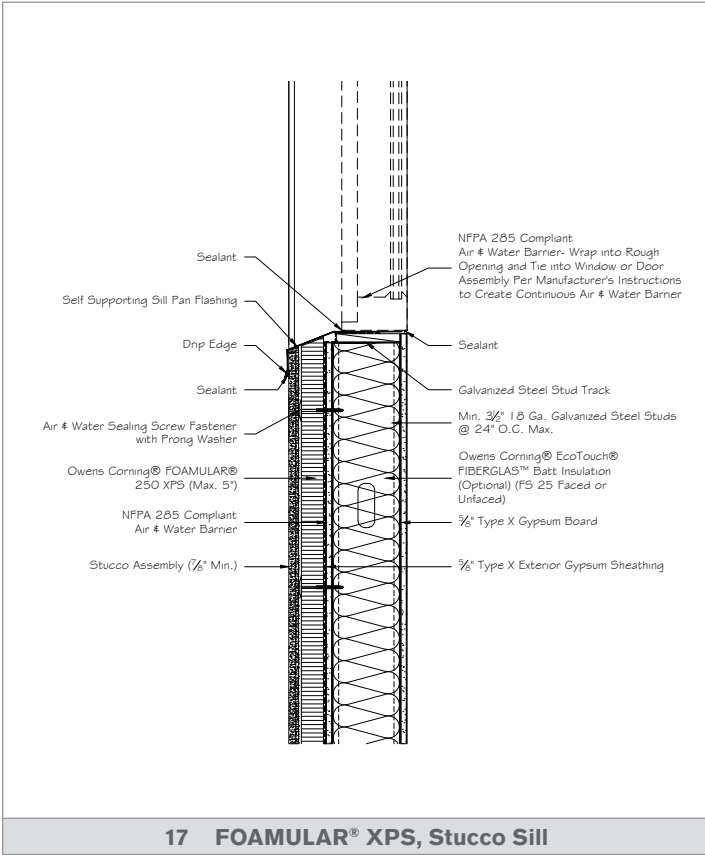

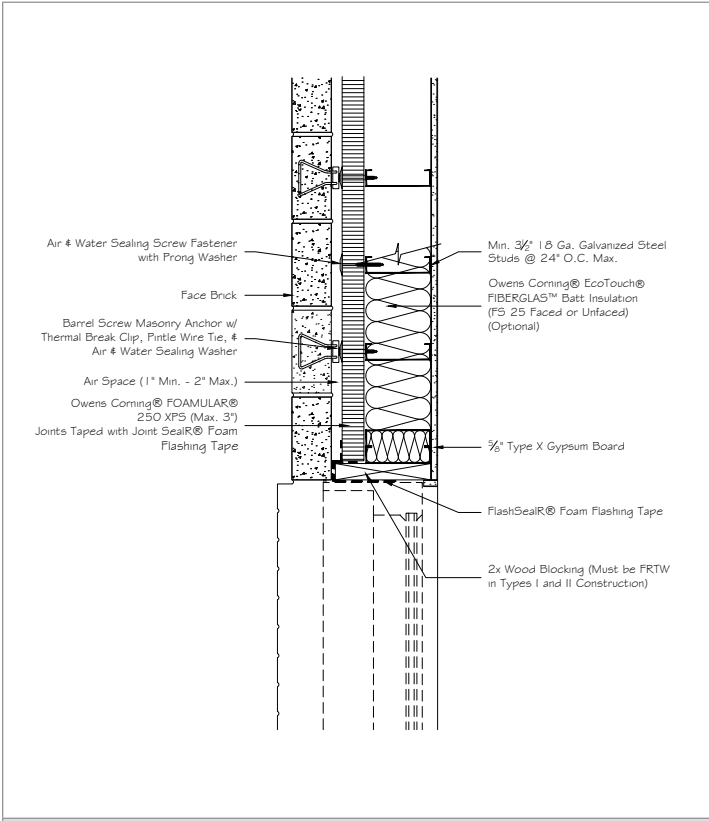

21 FOAMULAR® XPS, Steel Stud Jamb

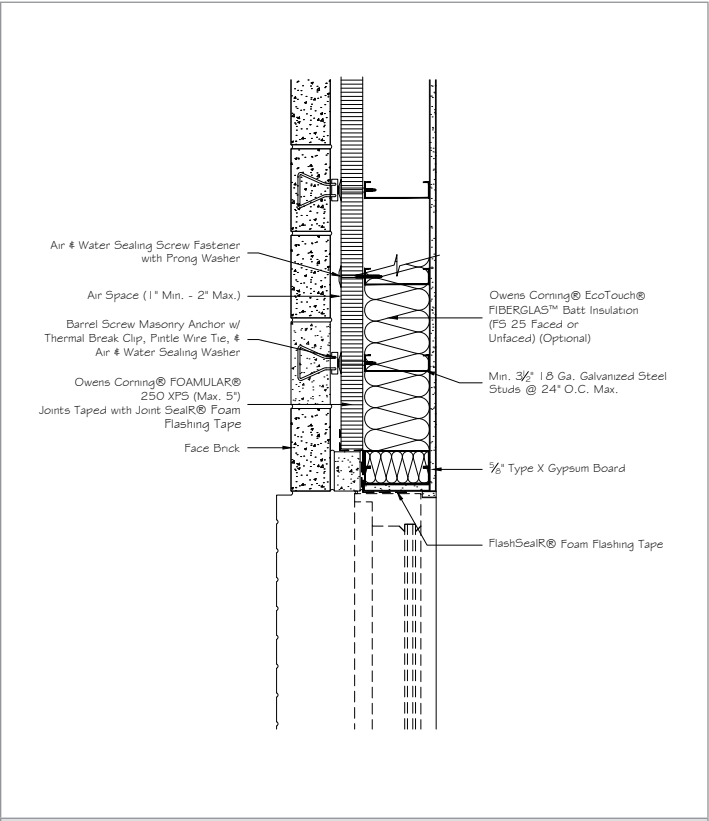

22 FOAMULAR® XPS, Steel Stud Jamb

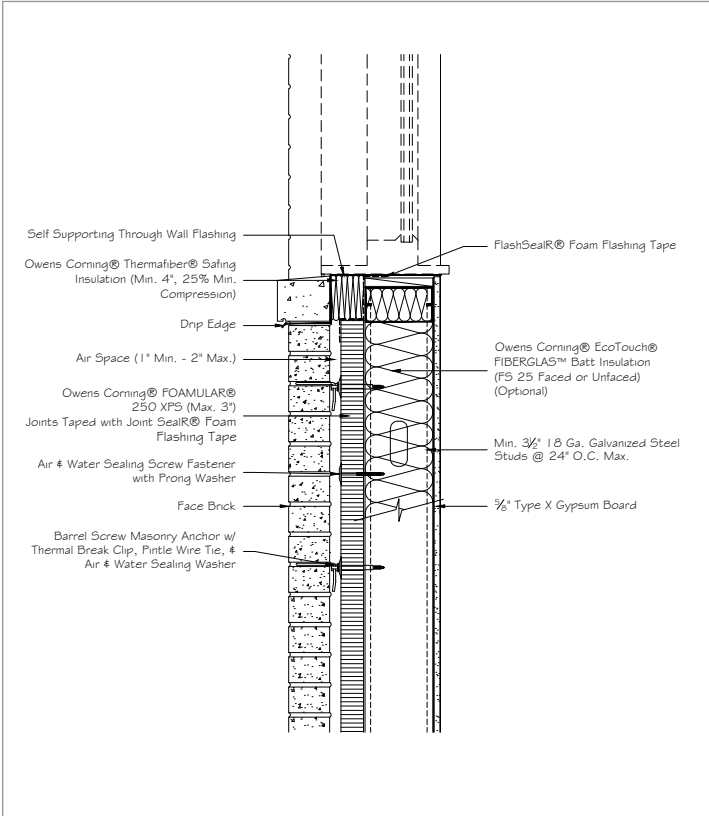

23 FOAMULAR® XPS, Steel Stud Sill

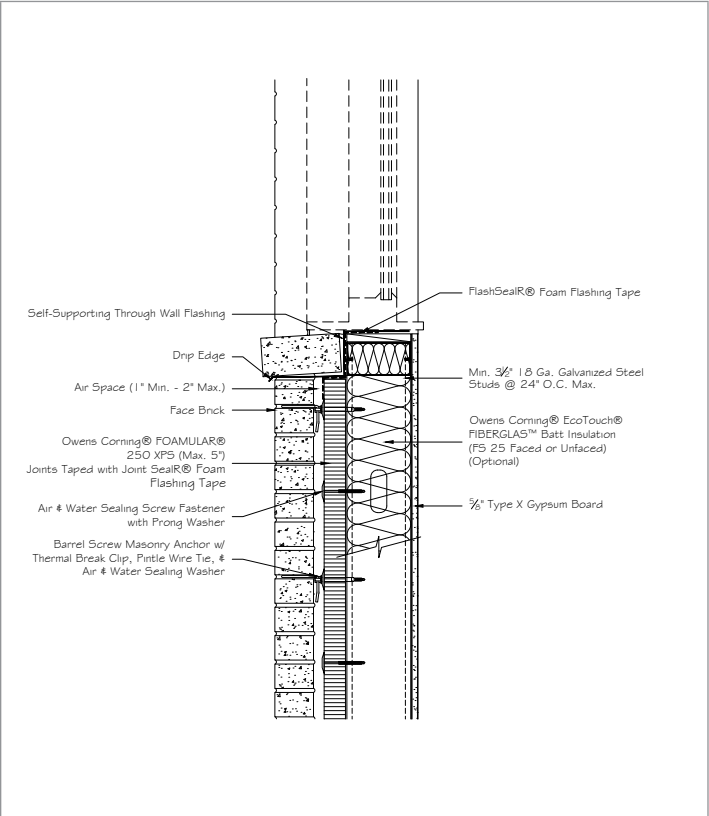

24 FOAMULAR® XPS, Steel Stud Sill

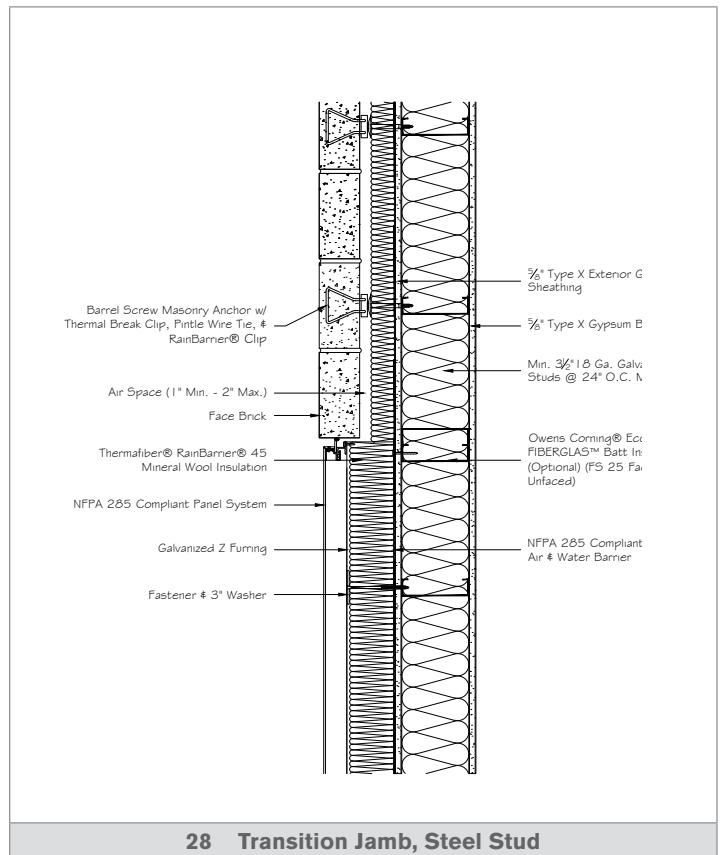
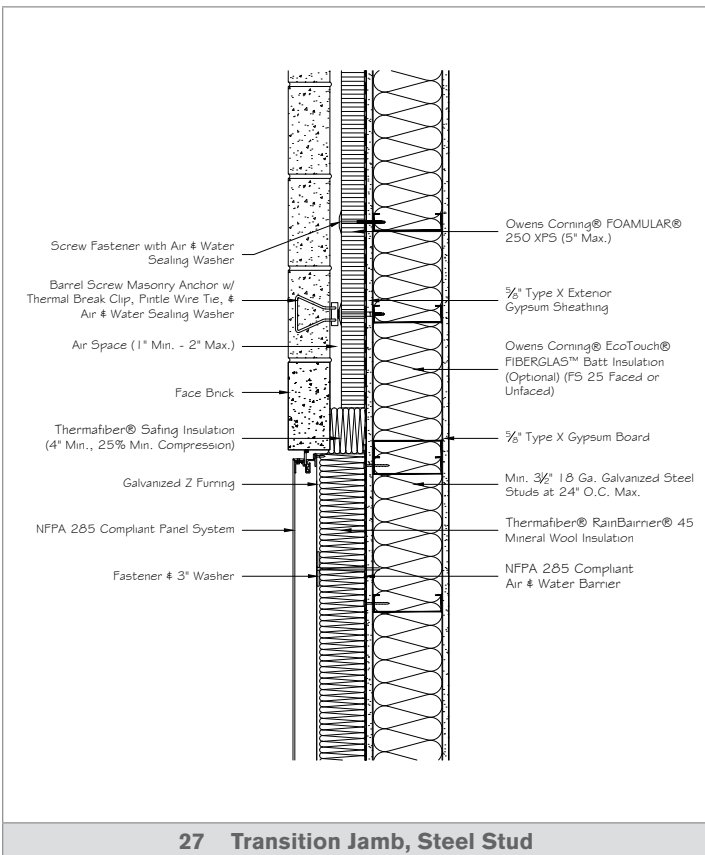
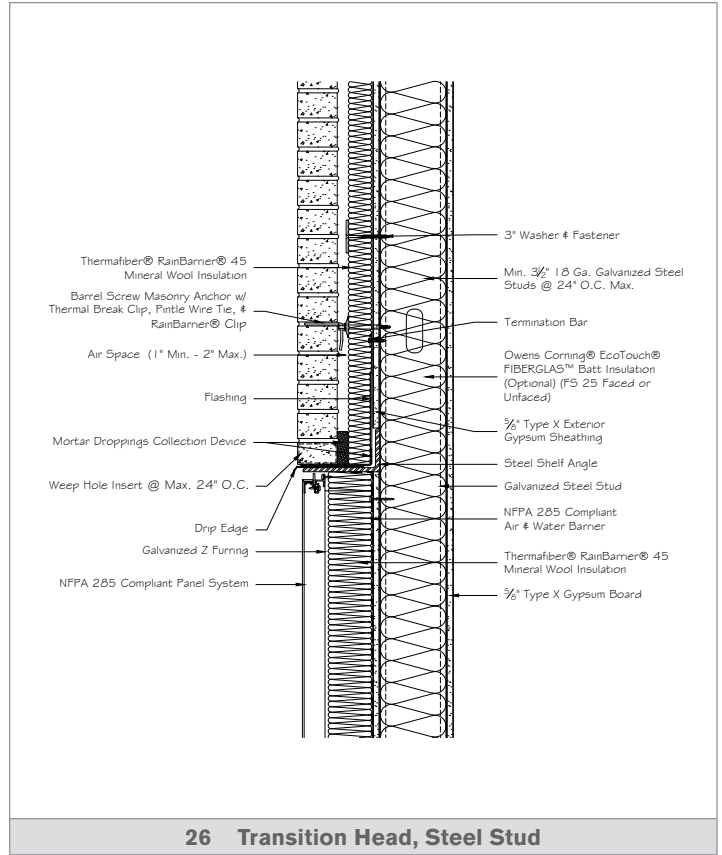
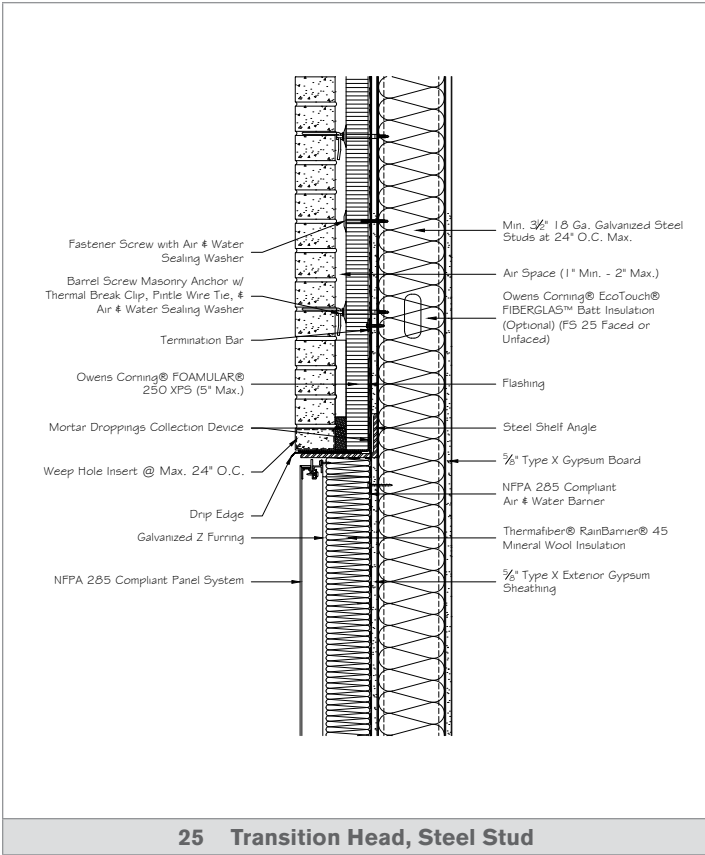

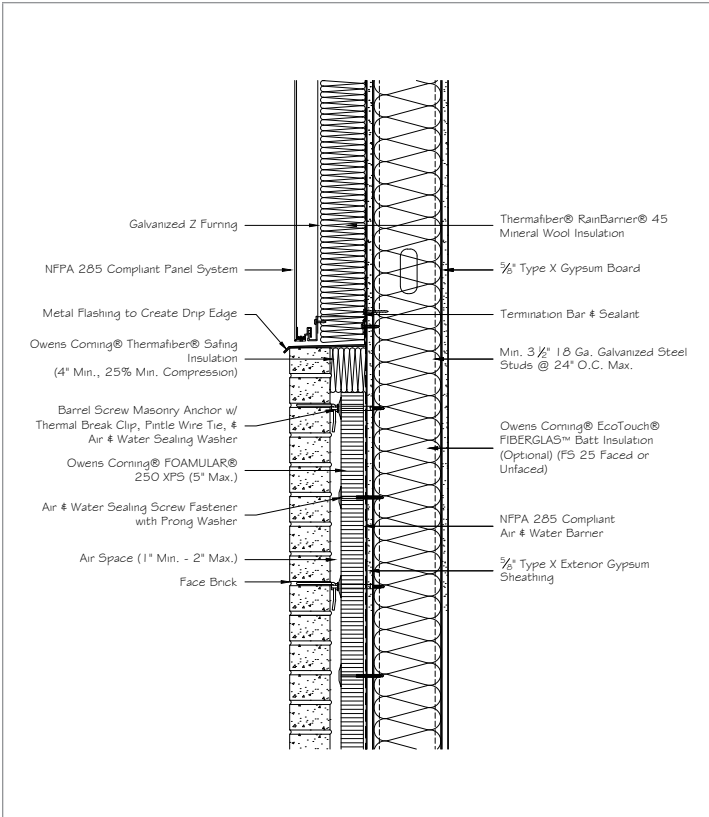

29 Transition Sill, Steel Stud

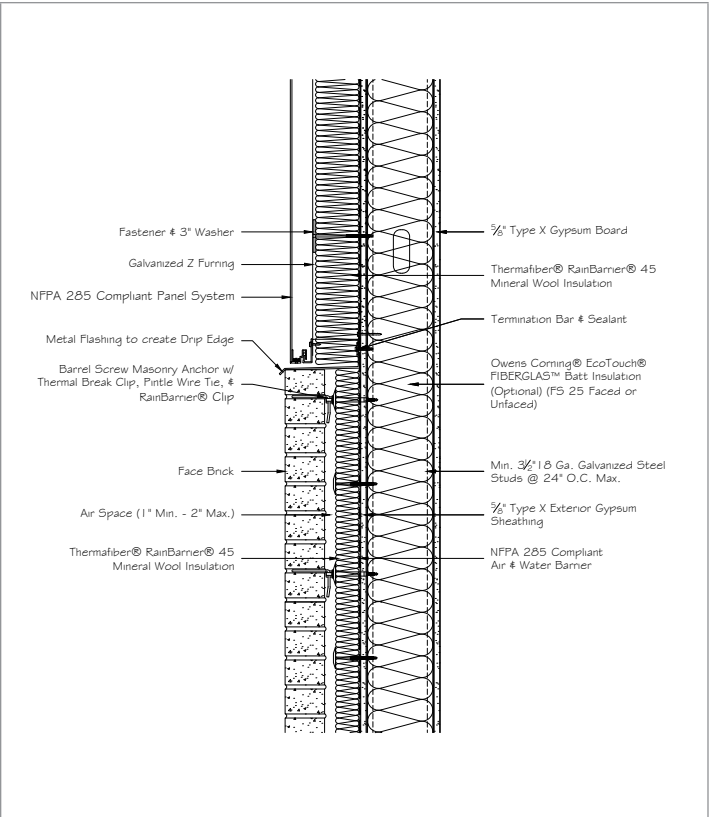

30 Transition Sill, Steel Stud

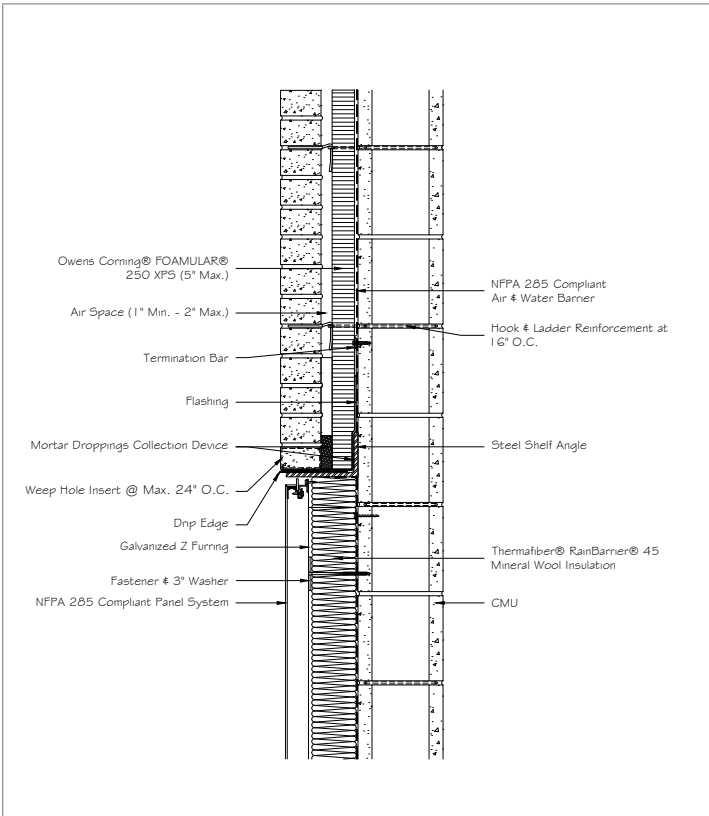

31 Transition Head, CMU

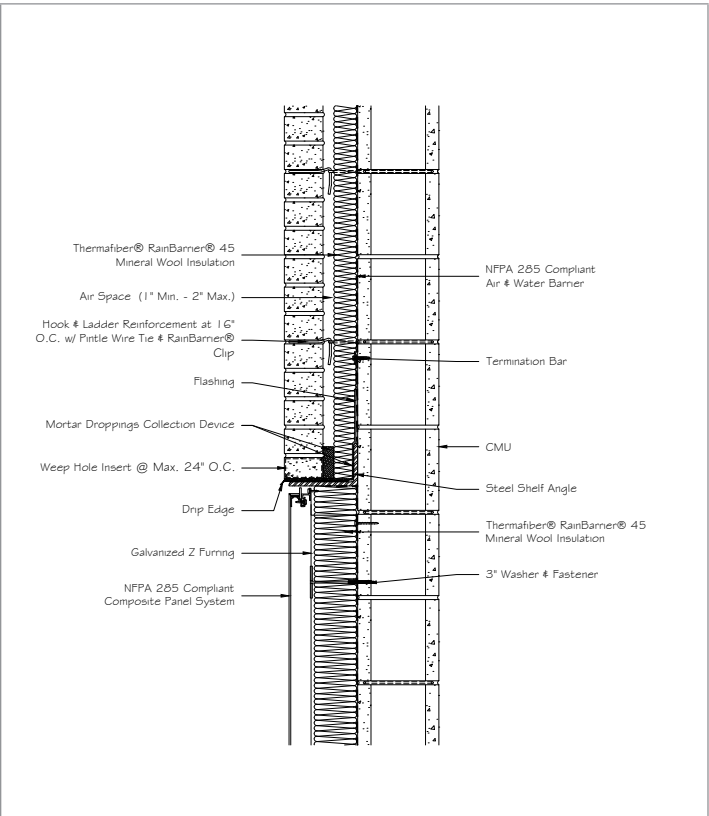

32 Transition Head, CMU

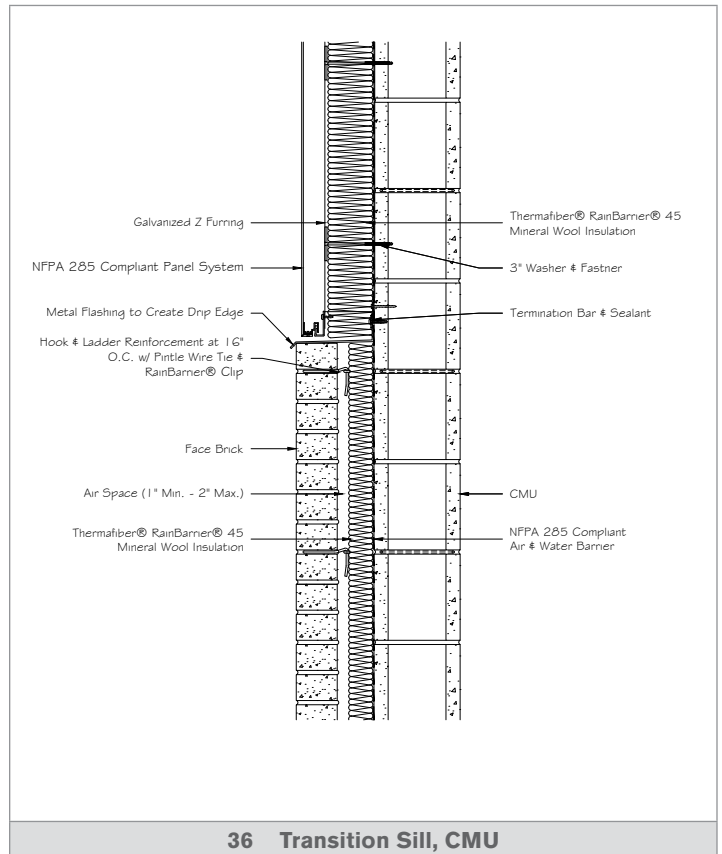
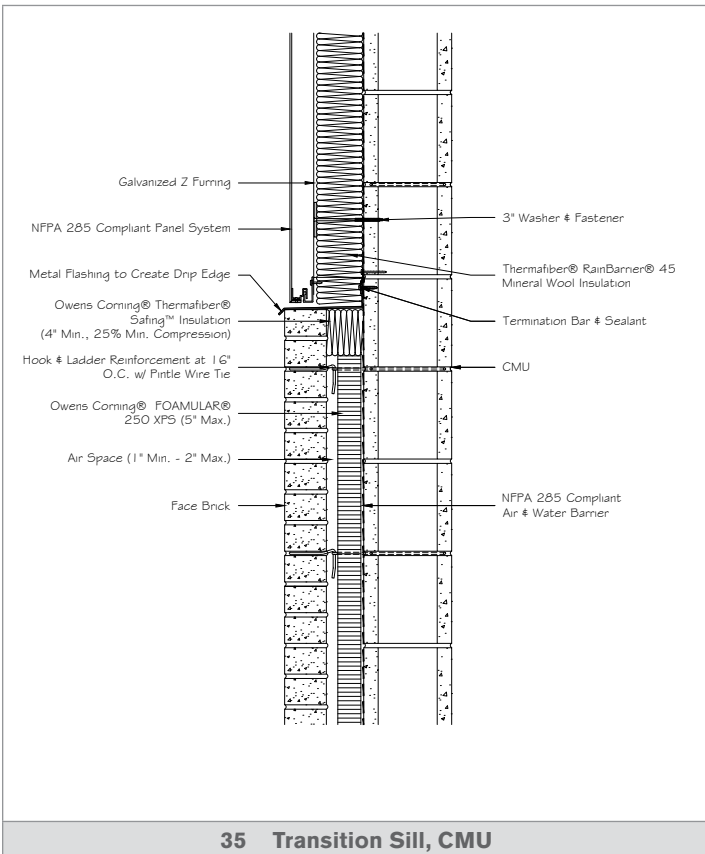
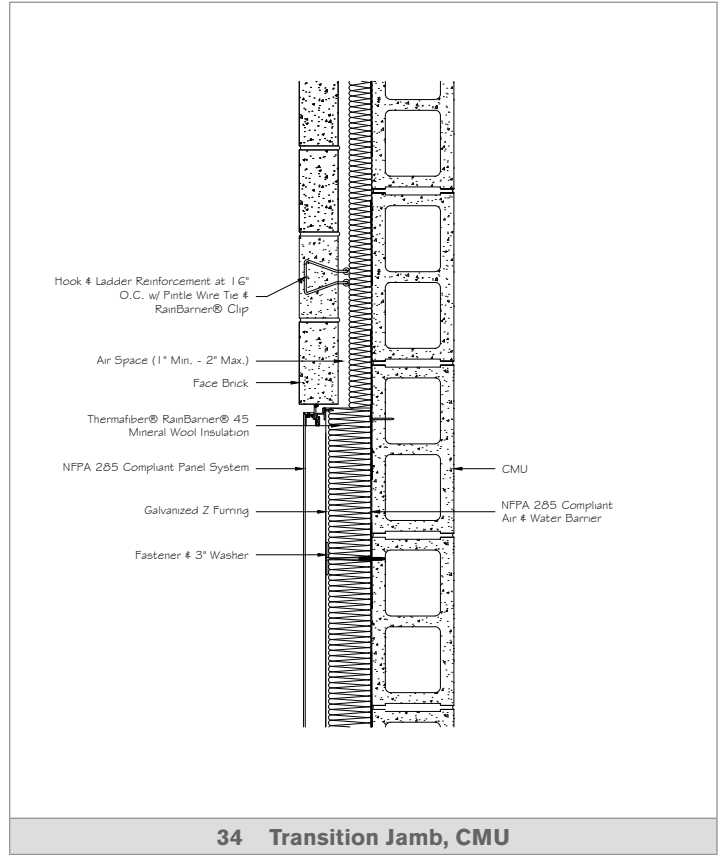
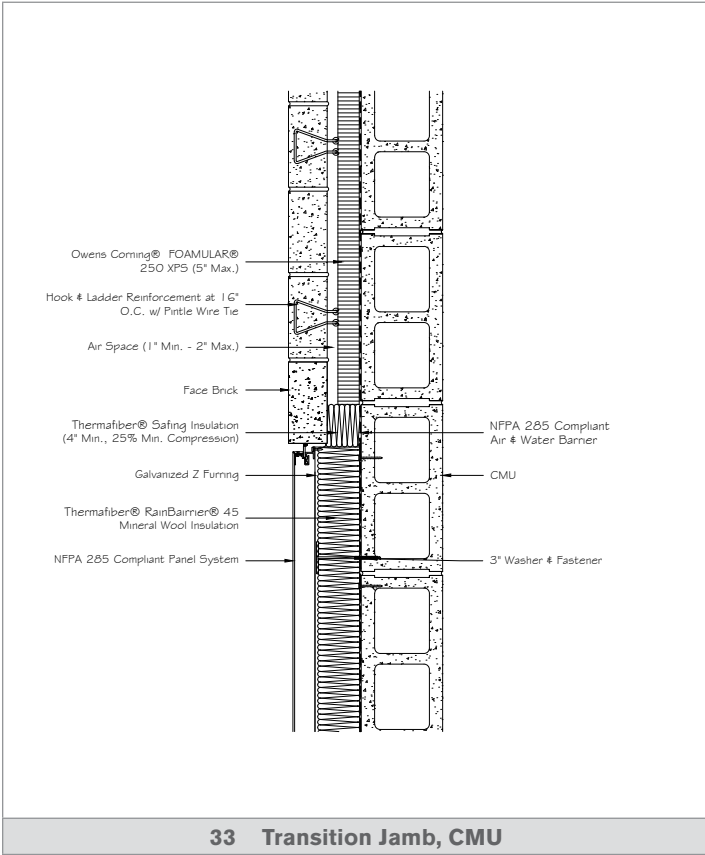

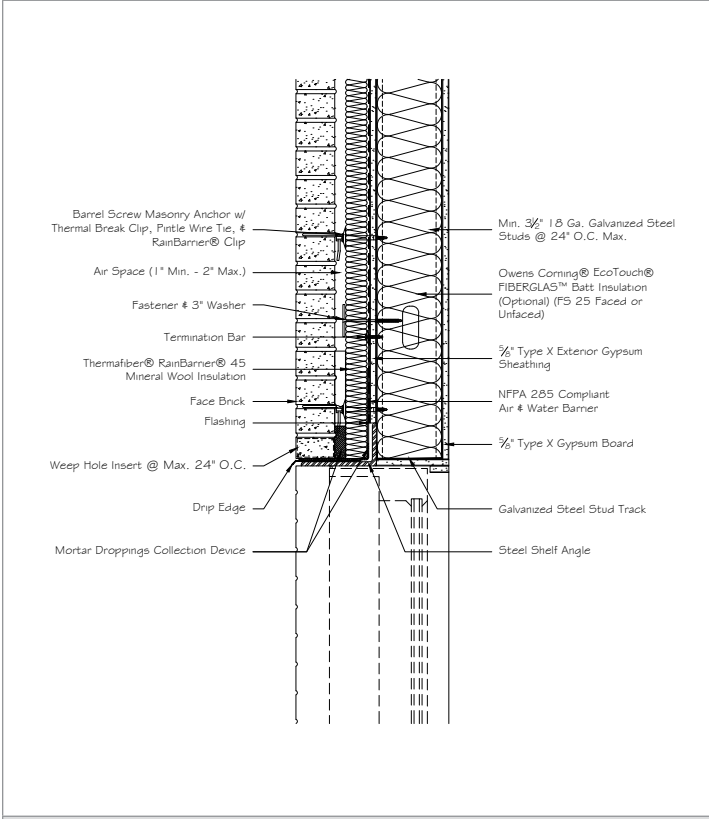

37 Thermafiber® MW, Steel Stud Head

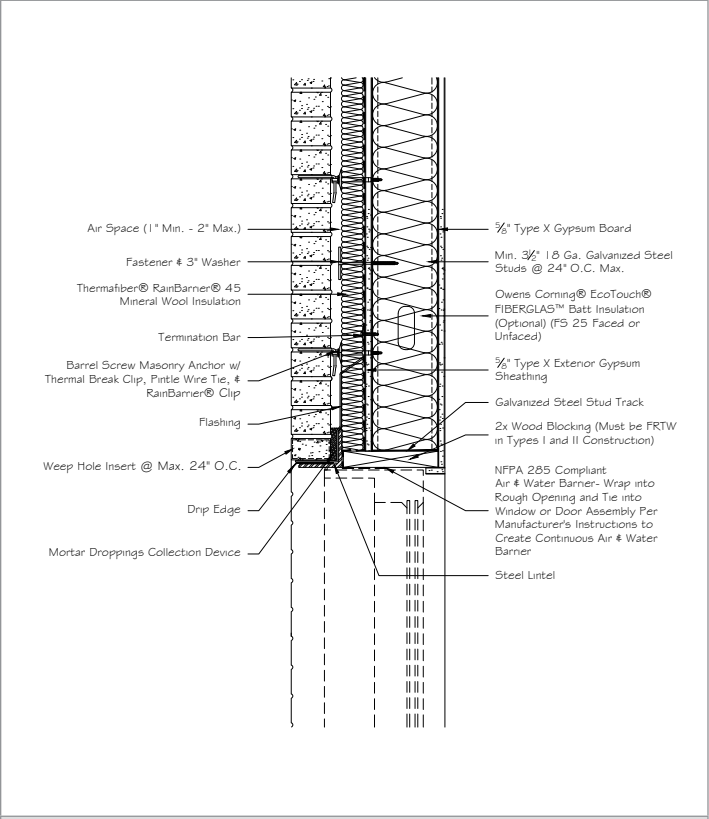

38 Thermafiber® MW, Steel Stud Head

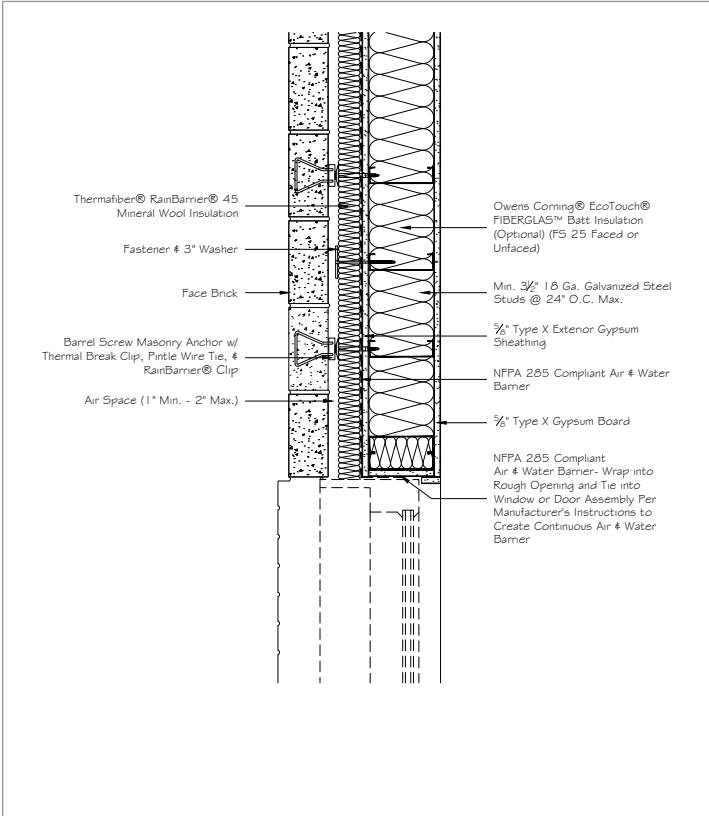

39 Thermafiber® MW, Steel Stud Jamb

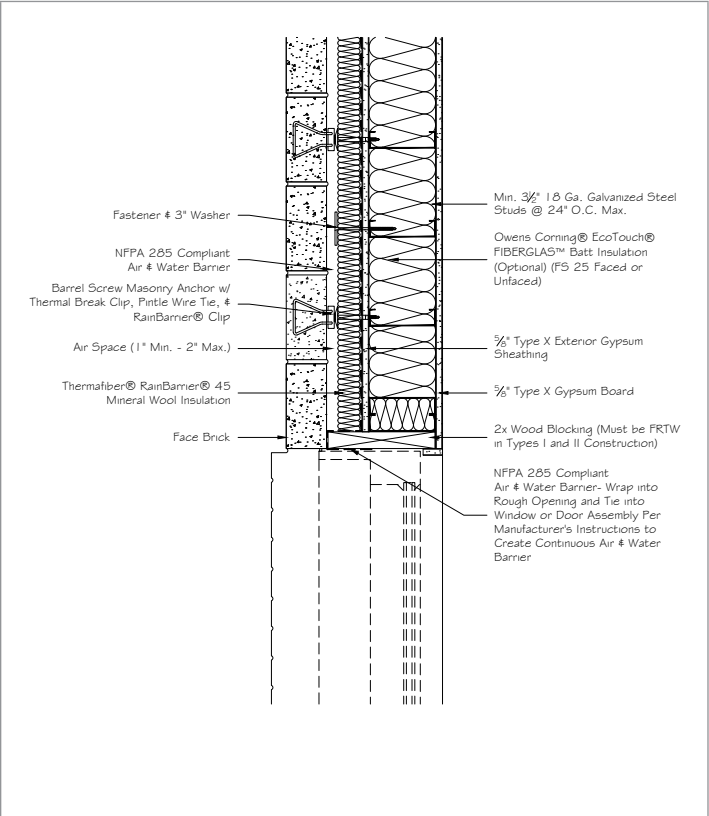

40 Thermafiber® MW, Steel Stud Jamb

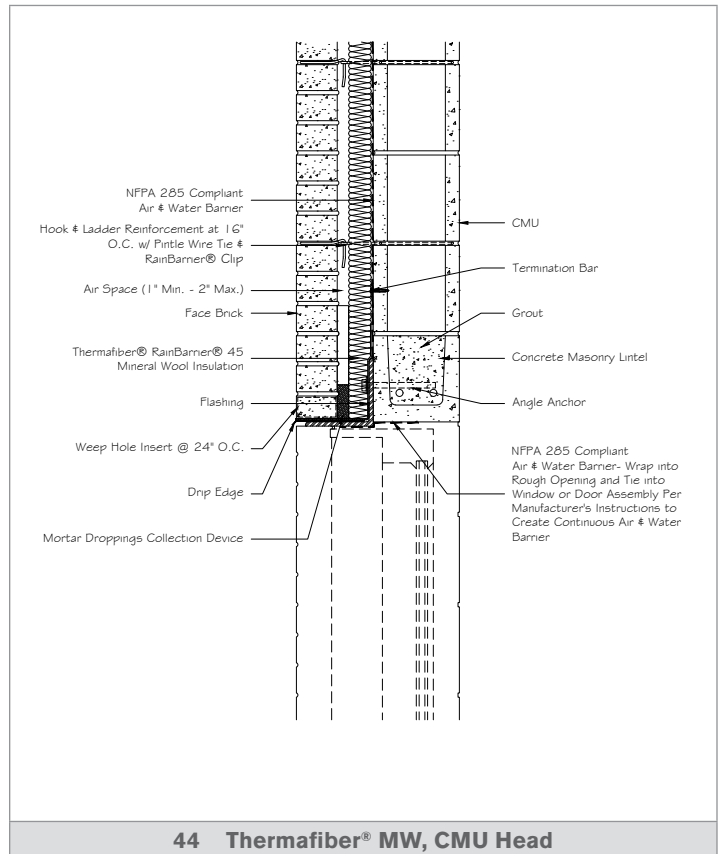
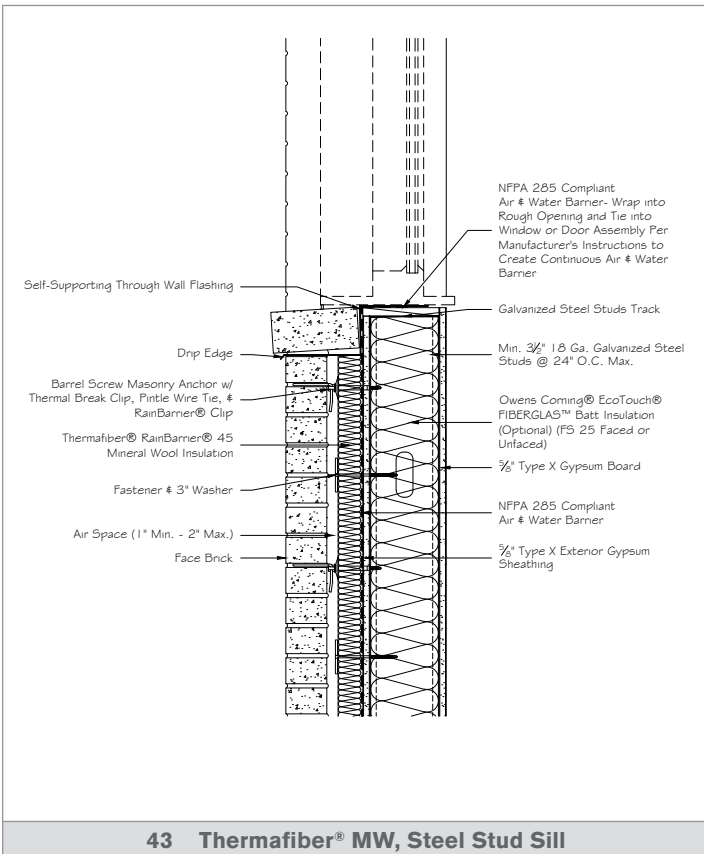
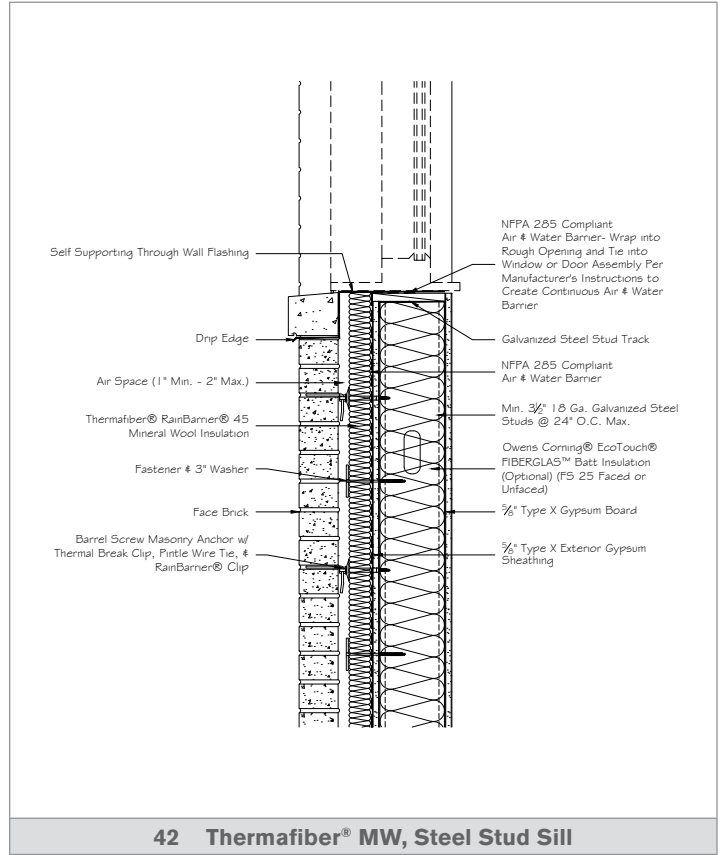
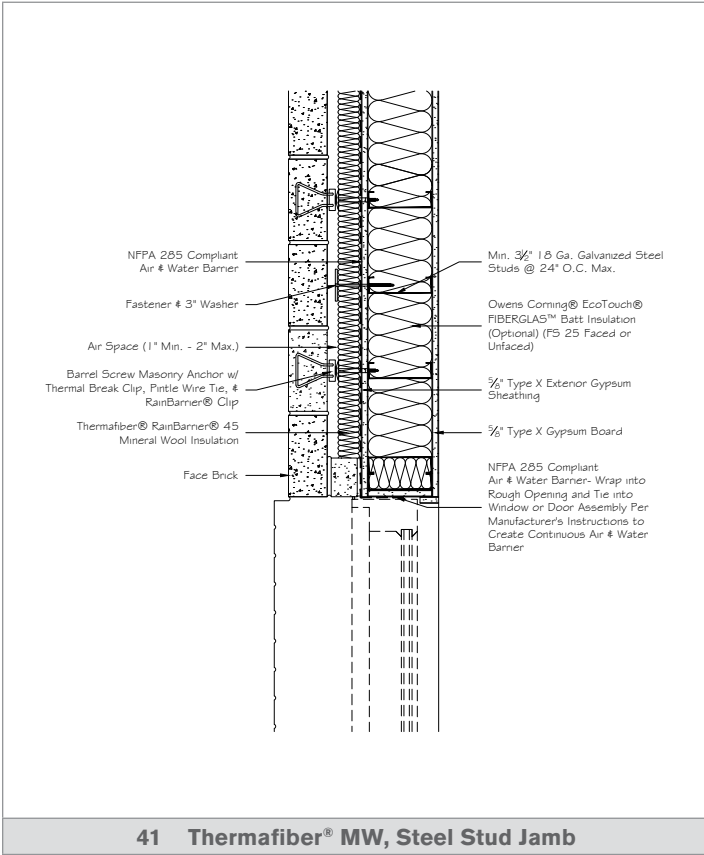

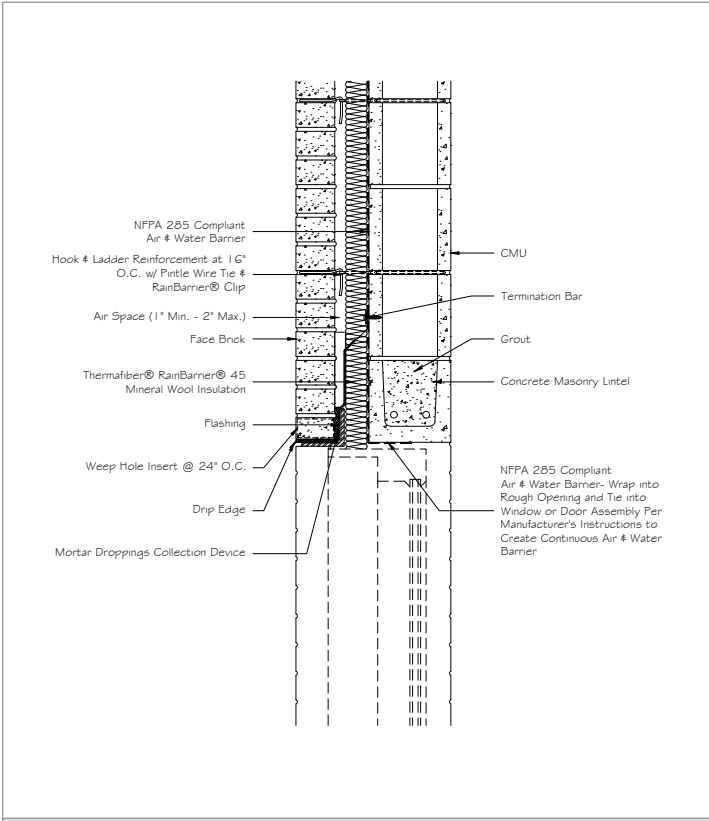

45 Thermafiber® MW, CMU Head

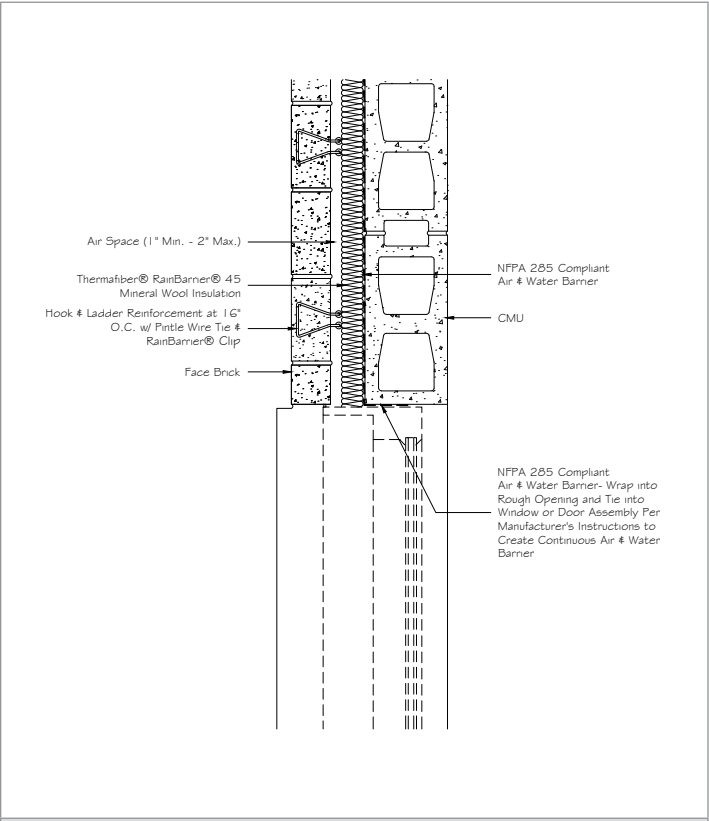

46 Thermafiber® MW, CMU Jamb

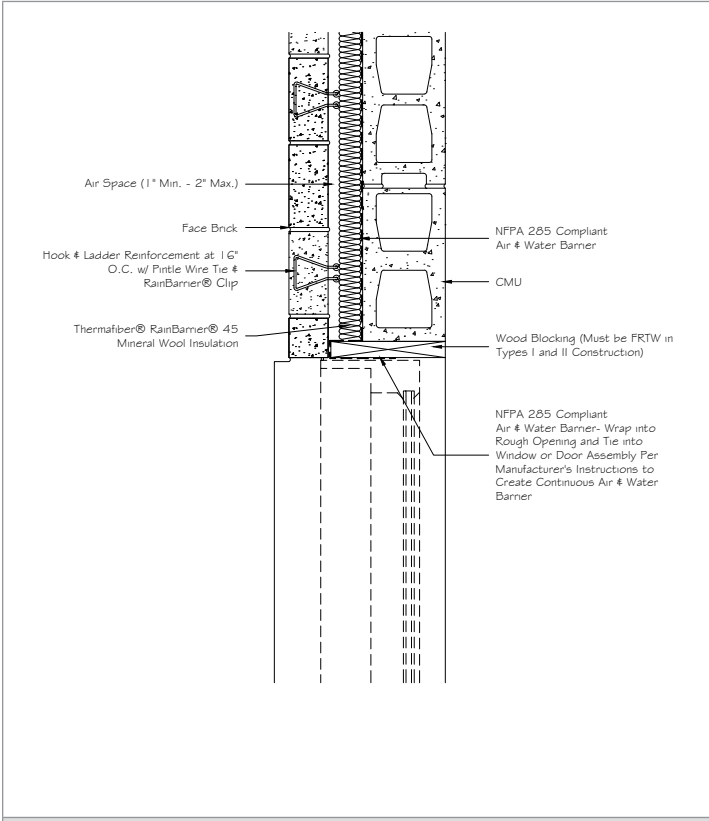

47 Thermafiber® MW, CMU Jamb

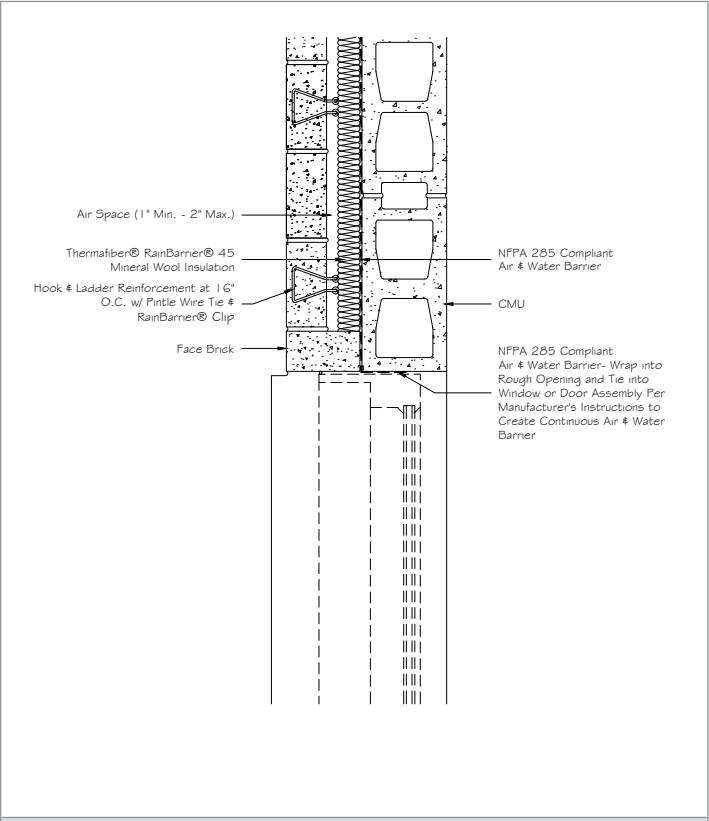

48 Thermafiber® MW, CMU Jamb

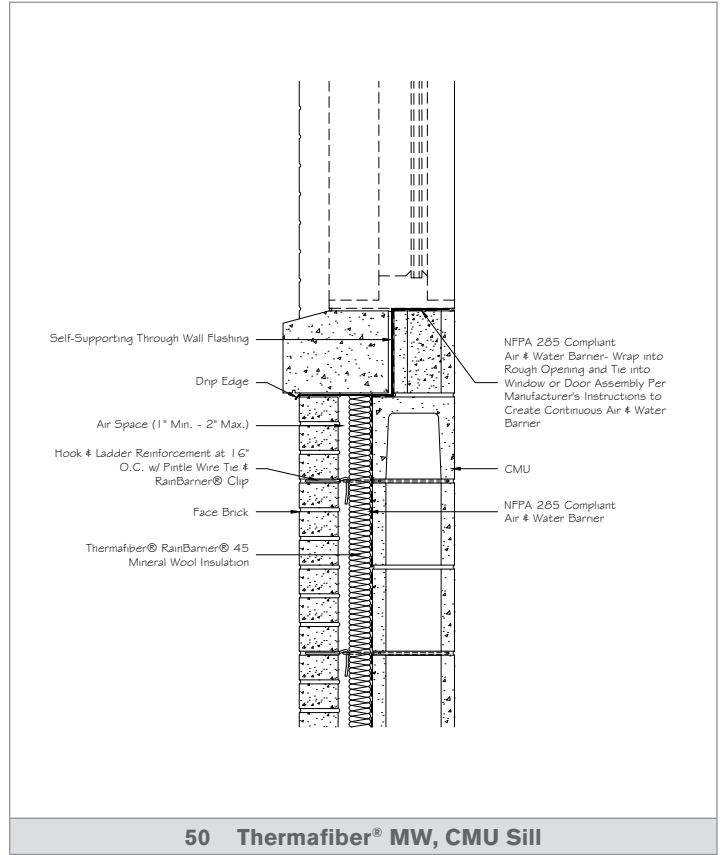
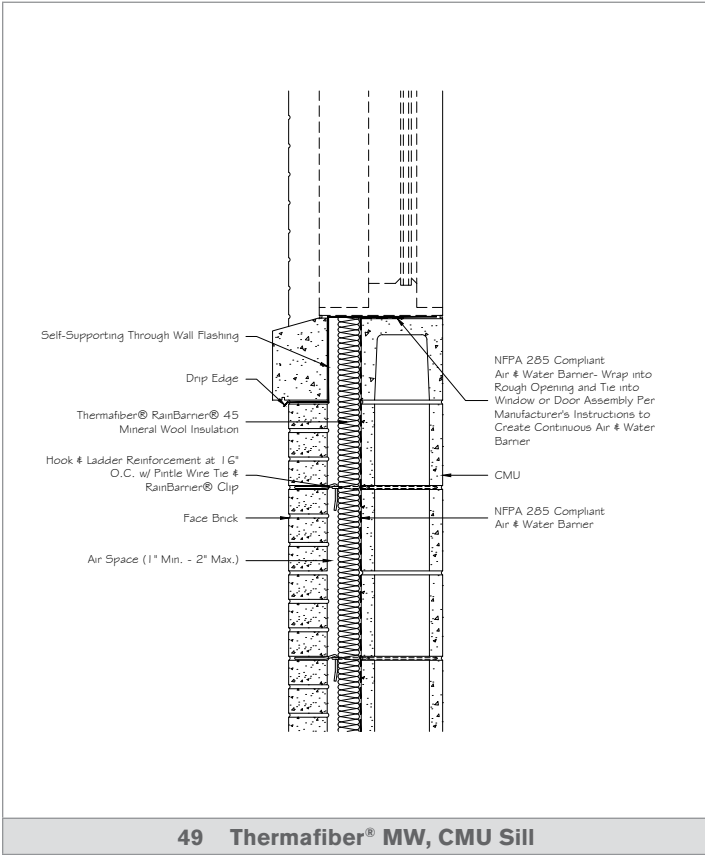

Owens Corning® Enclosure Solutions Resources:

For additional information see the complete set of Owens Corning®
Enclosure Solutions literature.

Visit owenscorning.com/enclosure, or call 1-800-GET-PINK®.



OWENS CORNING INSULATING SYSTEMS, LLC
ONE OWENS CORNING PARKWAY
TOLEDO, OHIO, USA 43659

1-800-GET-PINK®
www.owenscorning.com/enclosure

THERMAFIBER, INC.
ONE OWENS CORNING PARKWAY
TOLEDO, OHIO, USA 43659

888-TFIBER1 [834-2371]
www.thermafiber.com

Pub. No. 10020919. Printed in U.S.A. April 2016. THE PINK PANTHER™ &
© 1964–2016 Metro-Goldwyn-Mayer Studios Inc. All Rights Reserved. The
color PINK is a registered trademark of Owens Corning. © 2016 Owens Corning.
All Rights Reserved. © 2016 Thermafiber, Inc. All Rights Reserved. Trademarks
are the properties of their respective owners.

